

Characterization of acoustic and elastic parameters of porous media

Characterization of acoustic and elastic parameters of porous media

Thanks to
François-Xavier Bécot
Fabien Chevillotte
Stephen Hillenborg (for the inspiration)

These are the slides of the plenary lecture I gave during SAPEM 2011 - Ferrara, Italy.

I have drawn all images of Sponge Bob from scratch and credit his creator so I assume it is a fair use of intellectual property.
Correct me if I am wrong.

For more information on the topic of porous media characterization, check <http://apmr.matelys.com>
Section "Characterization of parameters"

NOTE I focus on porous materials...



NOTE | focus on porous materials... composed with 2 phases

ACOUSTIC characterization provides parameters describing visco-thermal dissipation in fluid phase.

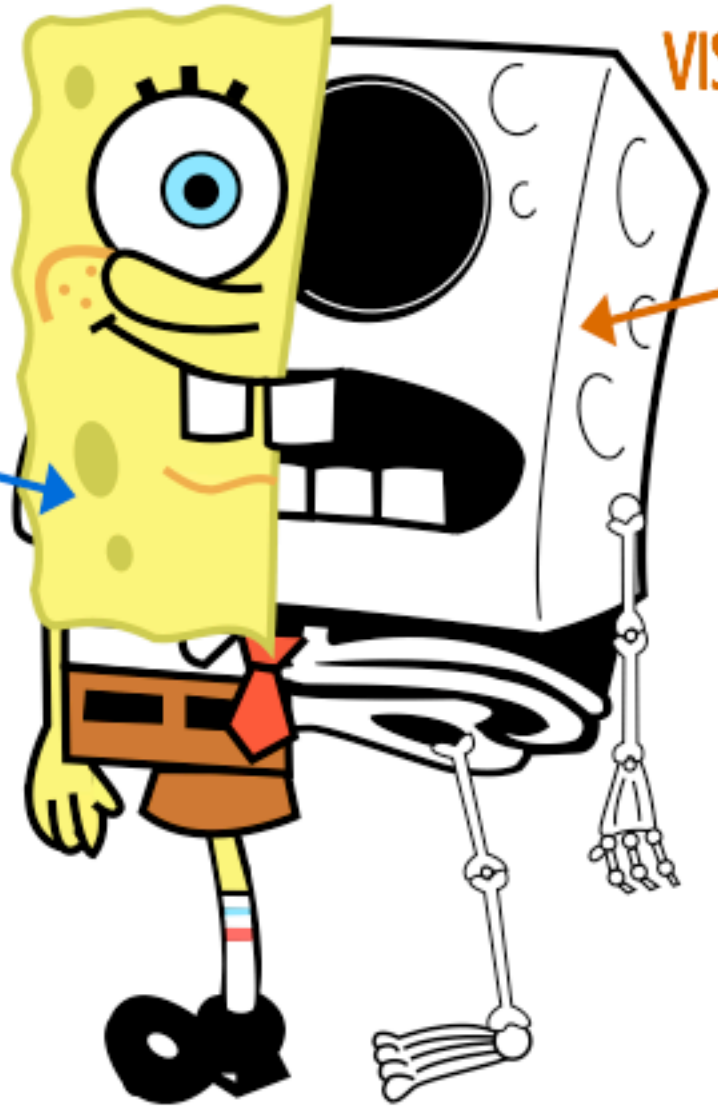

VISCO-ELASTIC characterization provides parameters describing the skeleton motion

OUTLINE

- Scientific issues
- Acoustic characterization
- Visco-elastic characterization
- Conclusion & perspectives

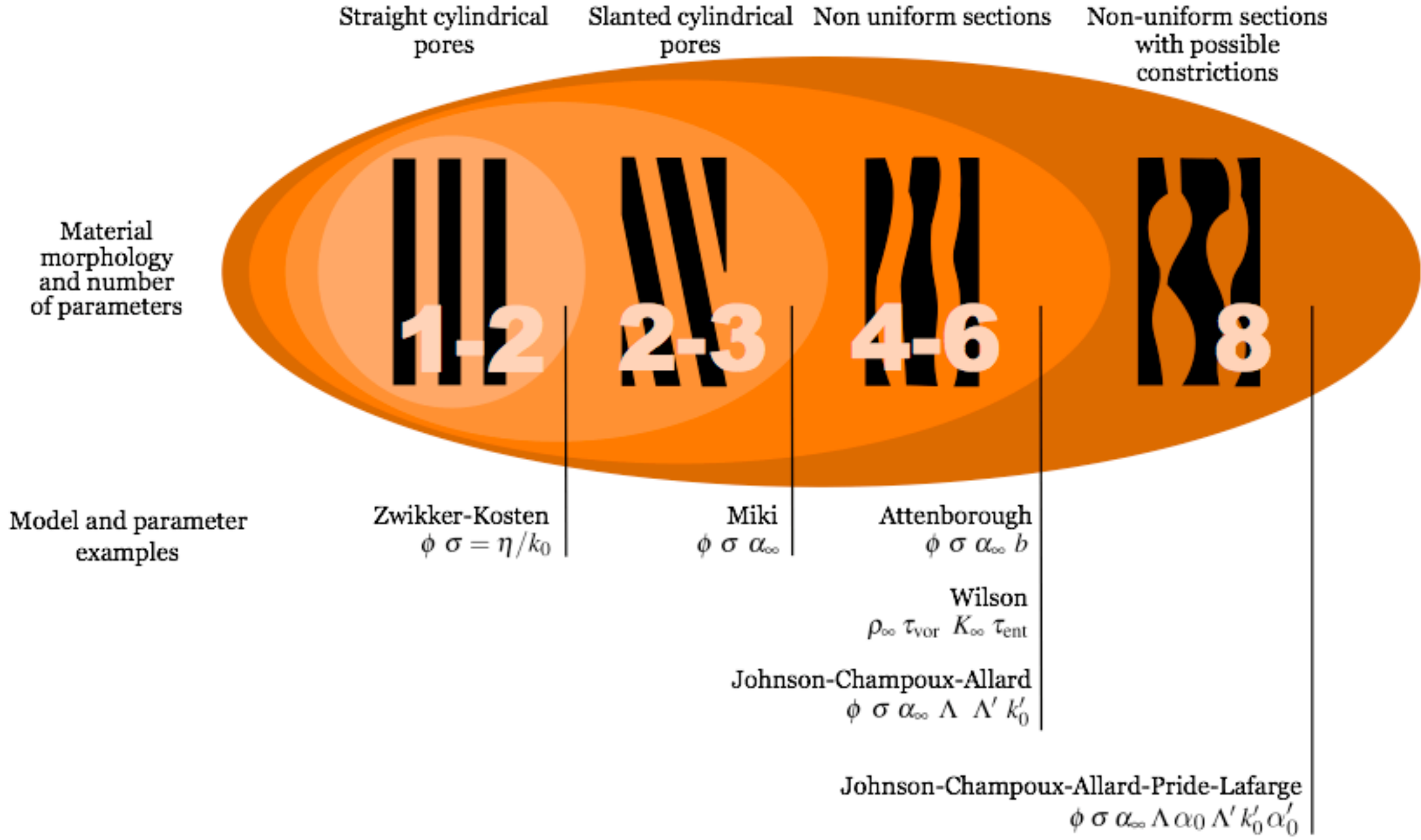

→ Most descriptive models need 5 to 8 acoustic parameters

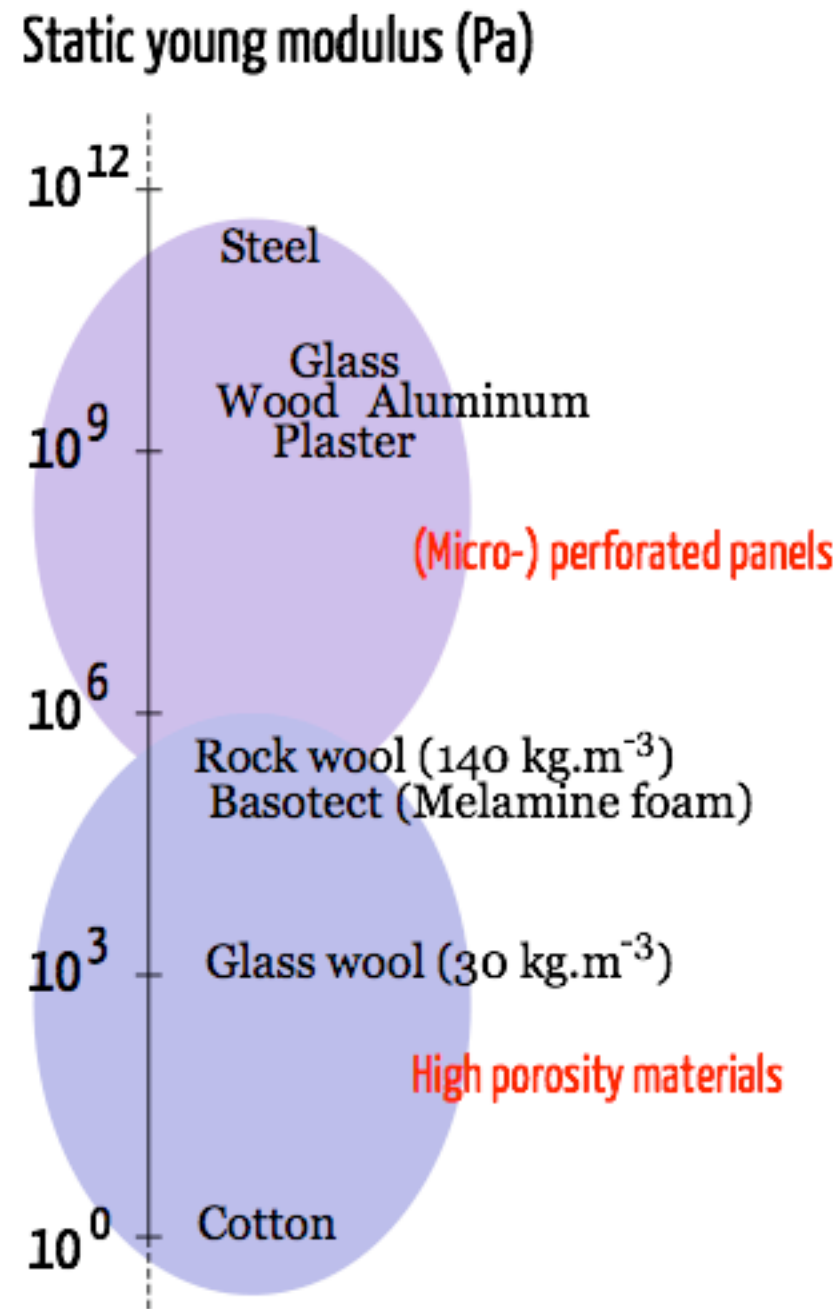

→ Values of elastic parameters almost cover the known range

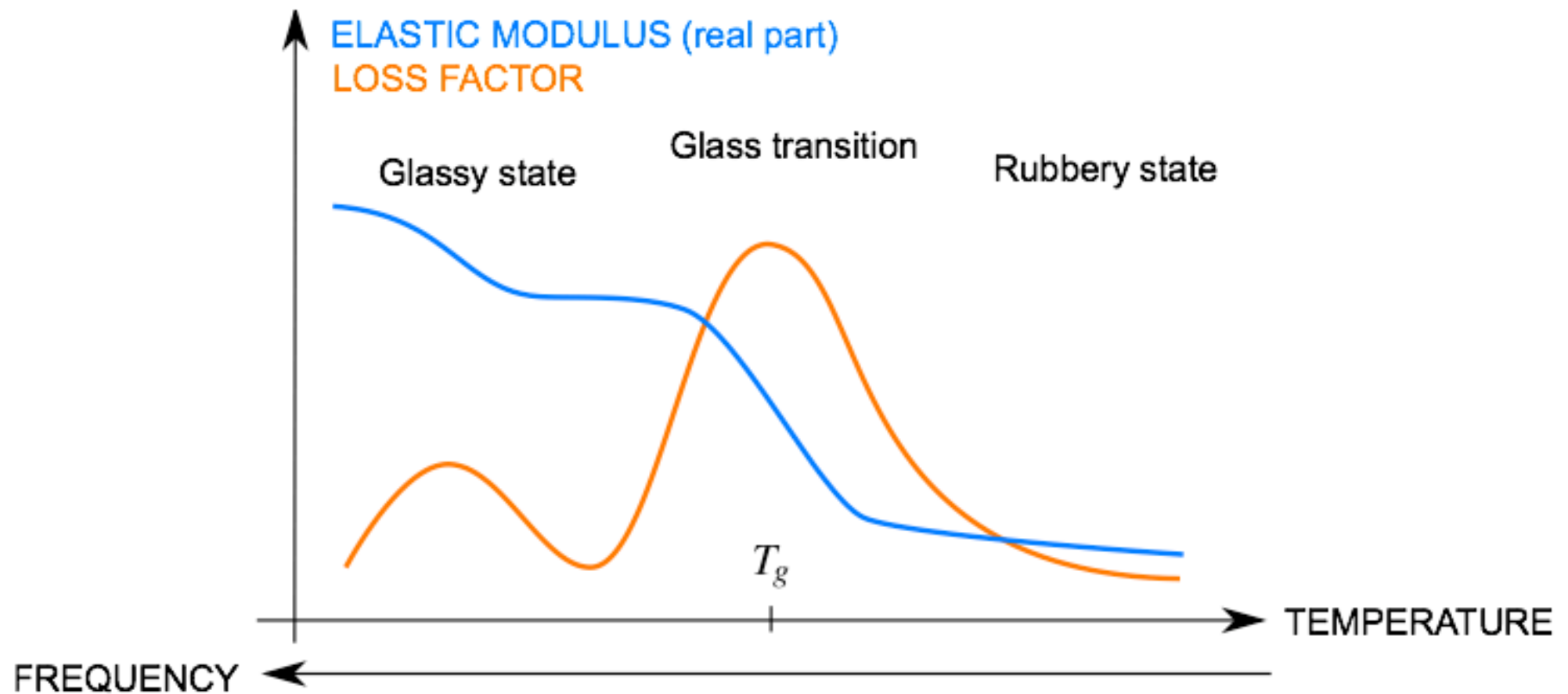

→ Glass transition around ambient temperature (i.e. in the audible freq. range) for most plastics



→ anisotropy of materials implies even more parameters to characterize

Melon et al. 1998, DOI: [10.1121/1.423897](https://doi.org/10.1121/1.423897)

Göransson et al. 2009, DOI: [10.1016/j.jsv.2009.06.028](https://doi.org/10.1016/j.jsv.2009.06.028)

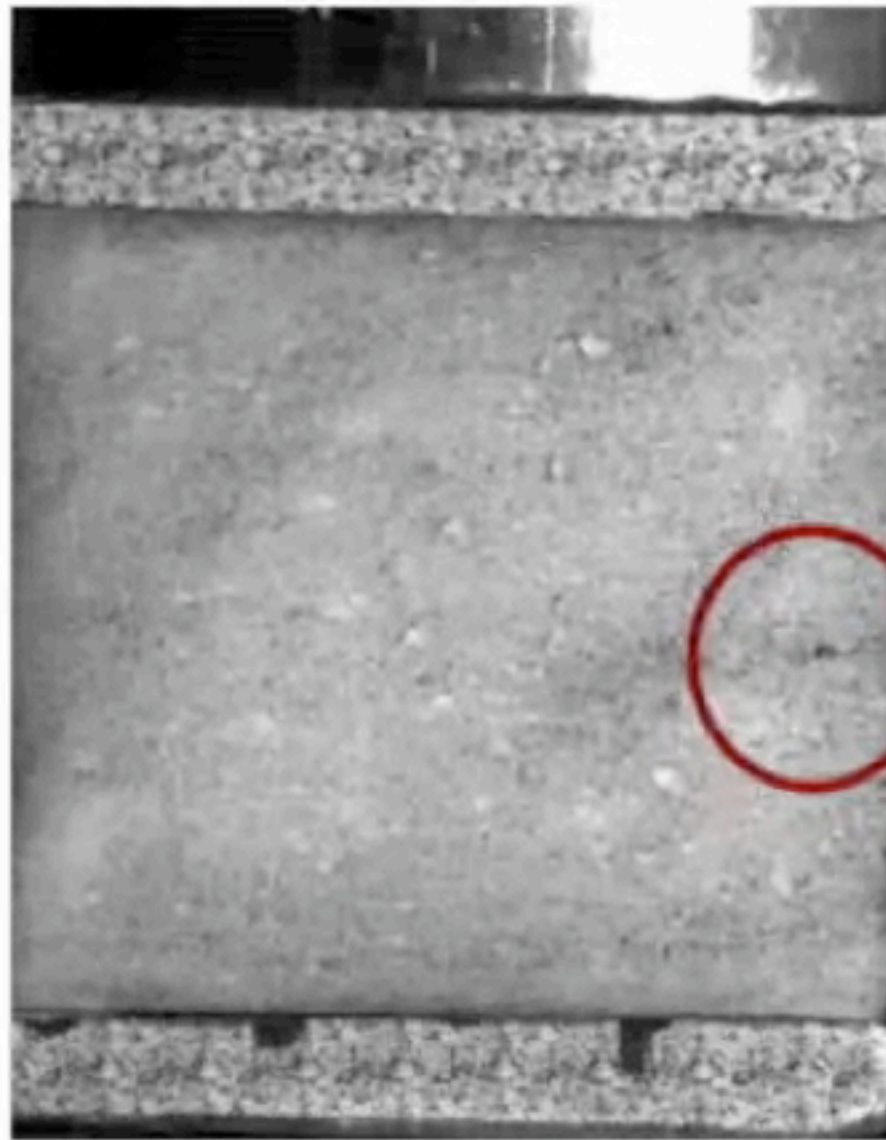

Video courtesy of P. Göransson

ACOUSTIC Characterization



Adjust parameter values to reduce the difference between measurements and numerical simulations

Techniques involve Monte-Carlo or genetic algorithms

M. Garoum 2008, link: sapem2008.matelys.com

Chazot et al. 2009, link: www.icsv16.org

Chedly et al. 2010, link: hal.inria.fr

Adjust parameter values to reduce the difference between measurements and numerical simulations

Techniques involve Monte-Carlo or genetic algorithms

PROS

Can be applied to all types of materials

CONS

Need a priori information

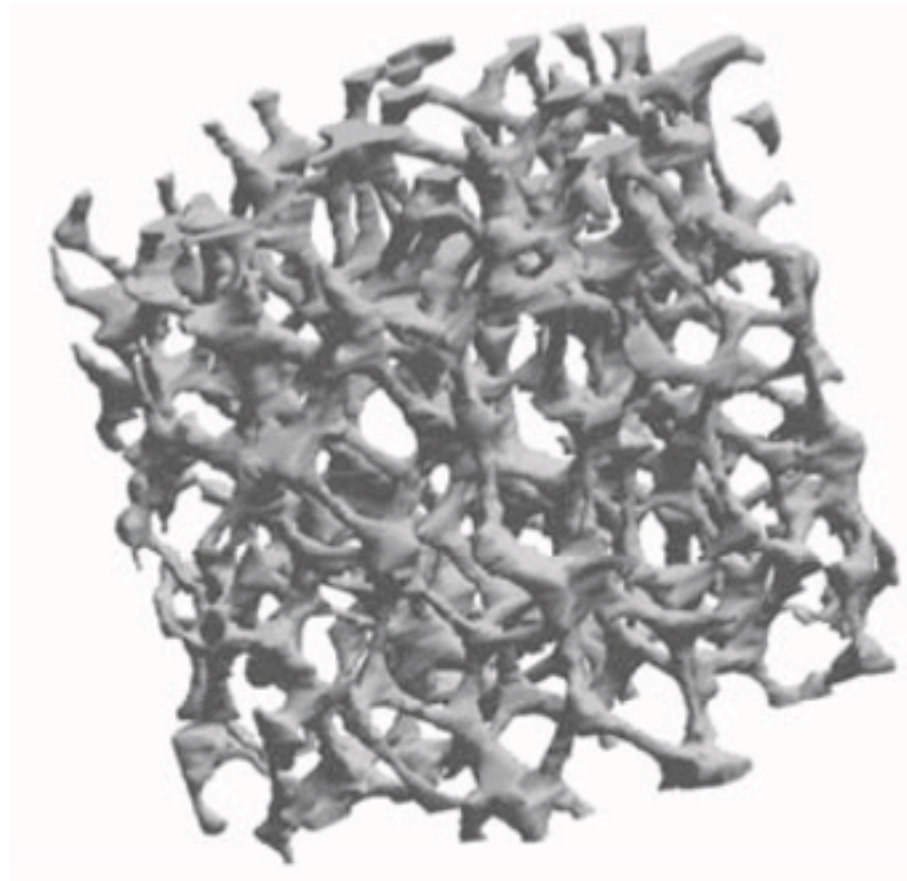

Picture courtesy of C. Perrot

P. Adler 1992, Link: www.sisyphe.upmc.fr/~adler/
S. Torquato 2002, Link: cherrypit.princeton.edu/sal.html

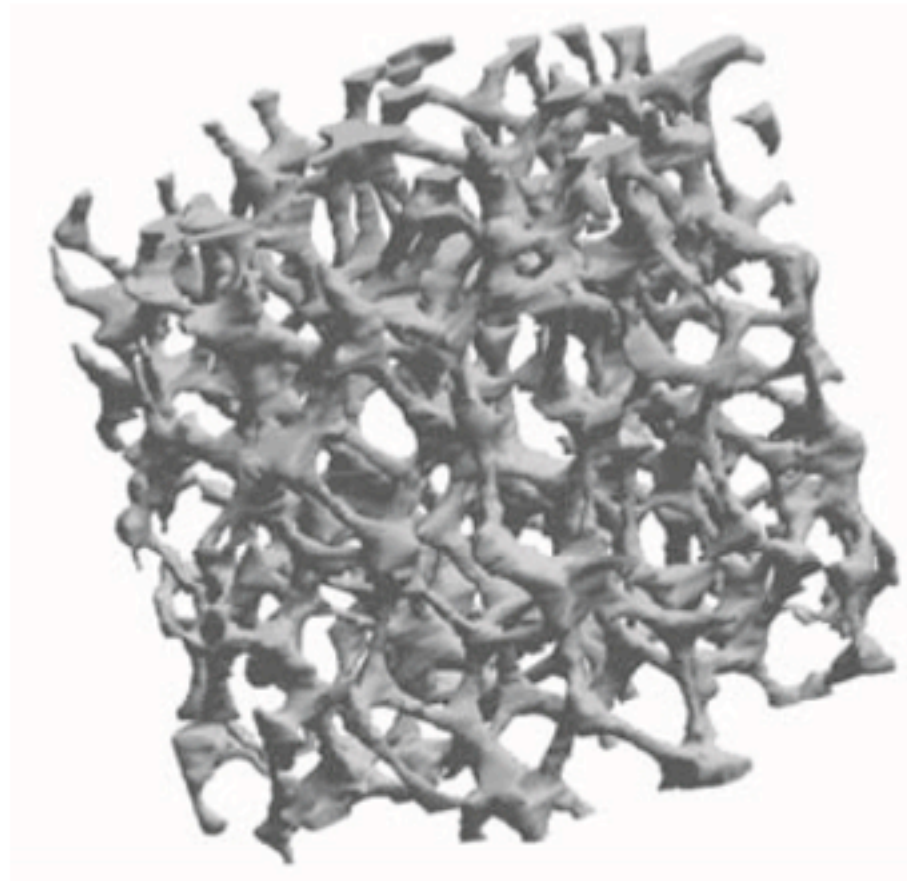

Picture courtesy of C. Perrot

PROS

Computation on 3D pore morphology.

CONS

Require important numerical resources.

Open porosity

Straight cylindrical pores

Slanted cylindrical pores

Non uniform sections

Non-uniform sections with possible constrictions

Material morphology and number of parameters

1-2

2-3

4-6

8

Model and parameter examples

Zwikker-Kosten
 ϕ $\sigma = \eta/k_0$

Miki
 ϕ σ α_∞

Attenborough
 ϕ σ α_∞ b

Wilson
 ρ_∞ τ_{vor} K_∞ τ_{ent}

Johnson-Champoux-Allard
 ϕ σ α_∞ Λ Λ' k'_0

Johnson-Champoux-Allard-Pride-Lafarge
 ϕ σ α_∞ Λ α_0 Λ' k'_0 α'_0

Open porosity

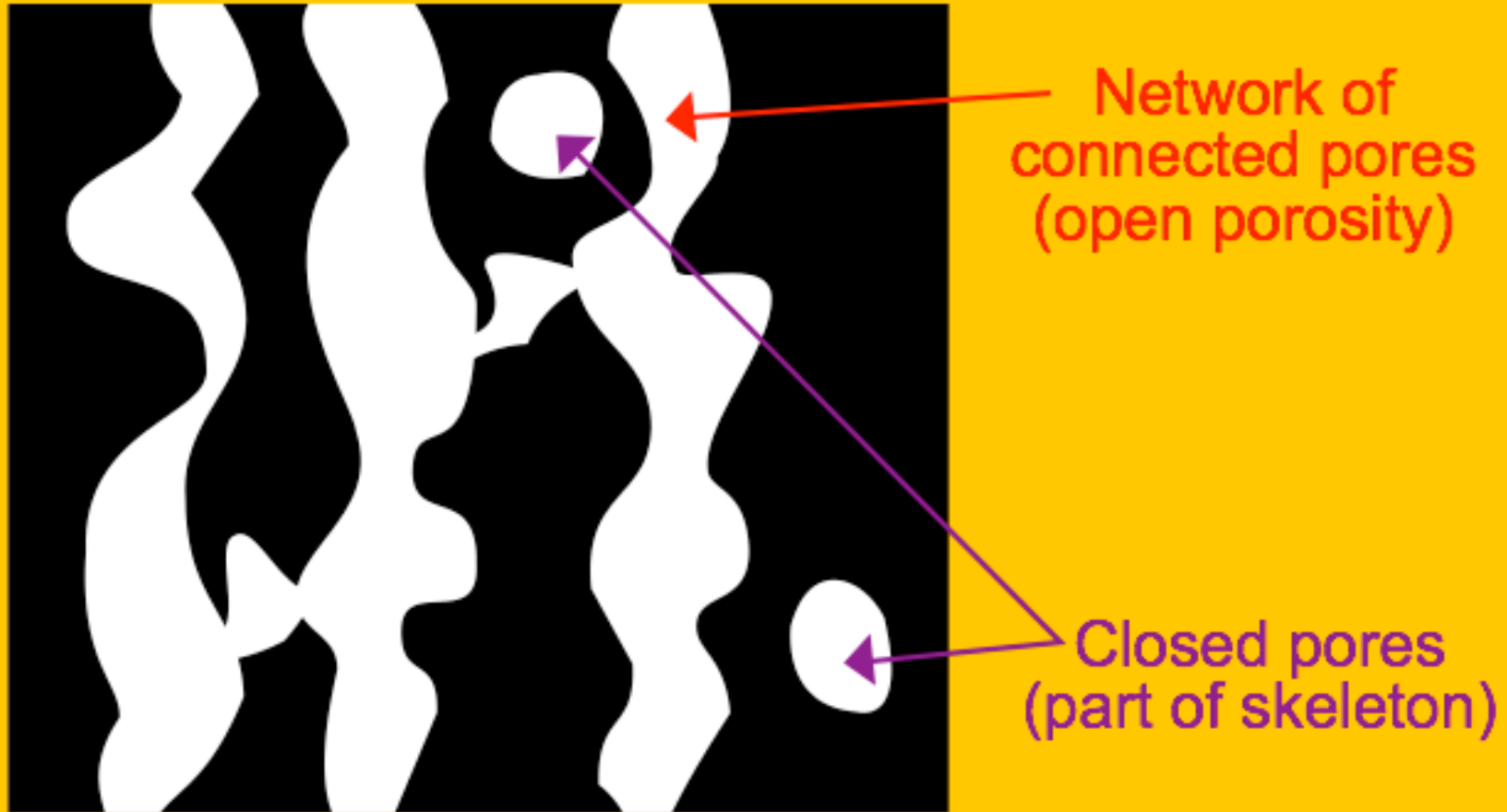

Range of values:
less than 0.01 to more than 0.99

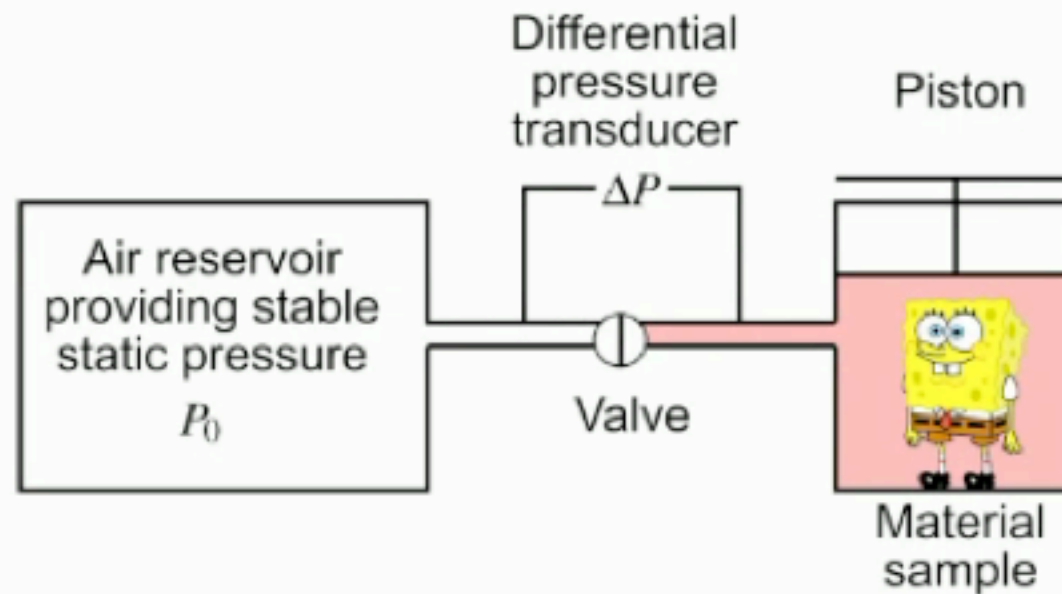

L. L. Beranek 1942, DOI: 10.1121/1.1916172

Champoux et al. 1990, DOI: 10.1121/1.1894653

Leclaire et al. 2003, DOI: 10.1063/1.1542666

ISO 4590 (2002), Link: www.iso.org

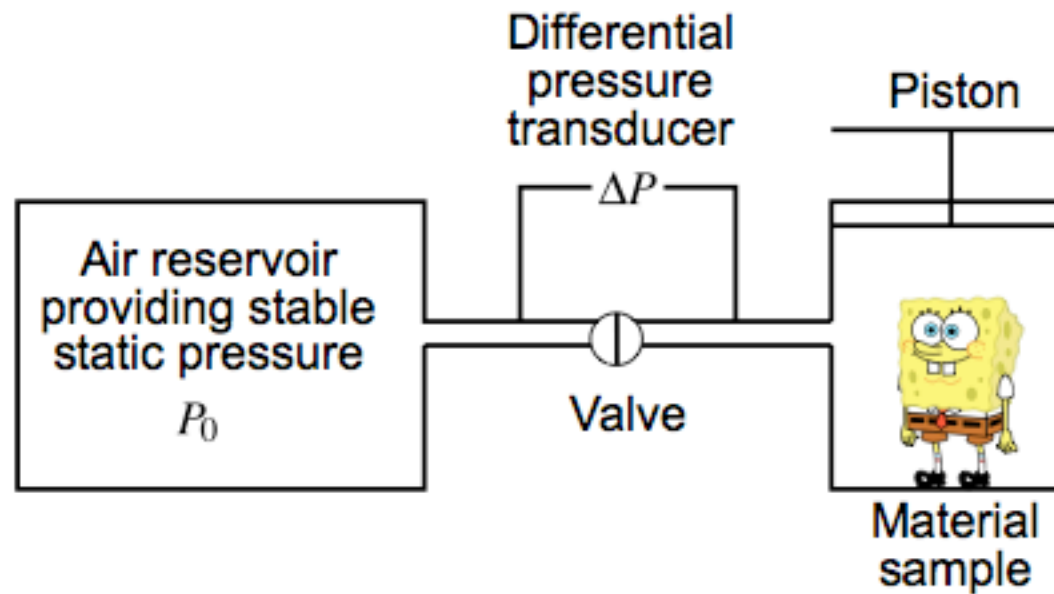
**PROS**

Applied on all types of materials
Accuracy of 0.01

CONS

Larger samples give accurate results

Method based on Archimedes' principle

1



2

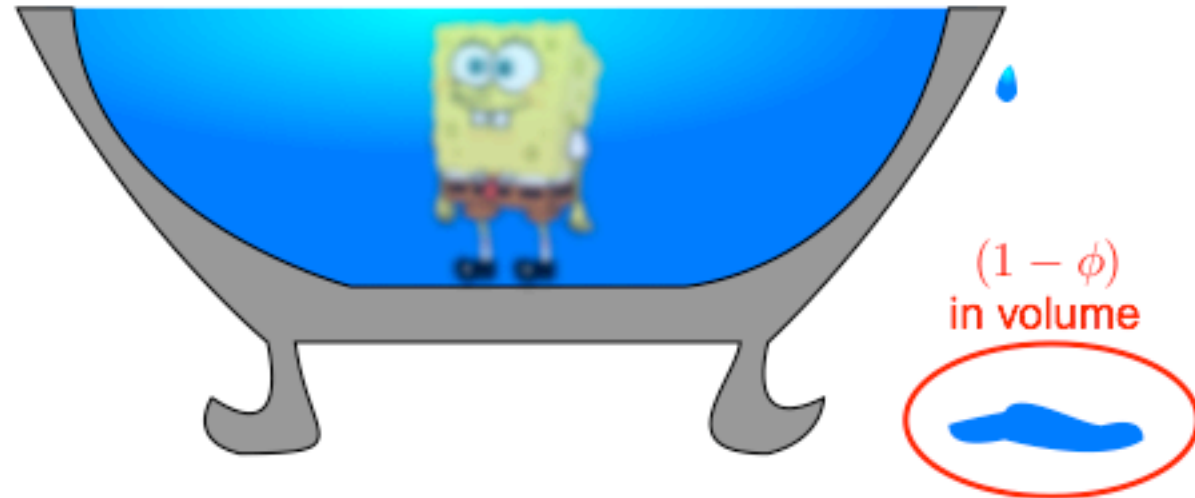

Method based on Archimedes' principle

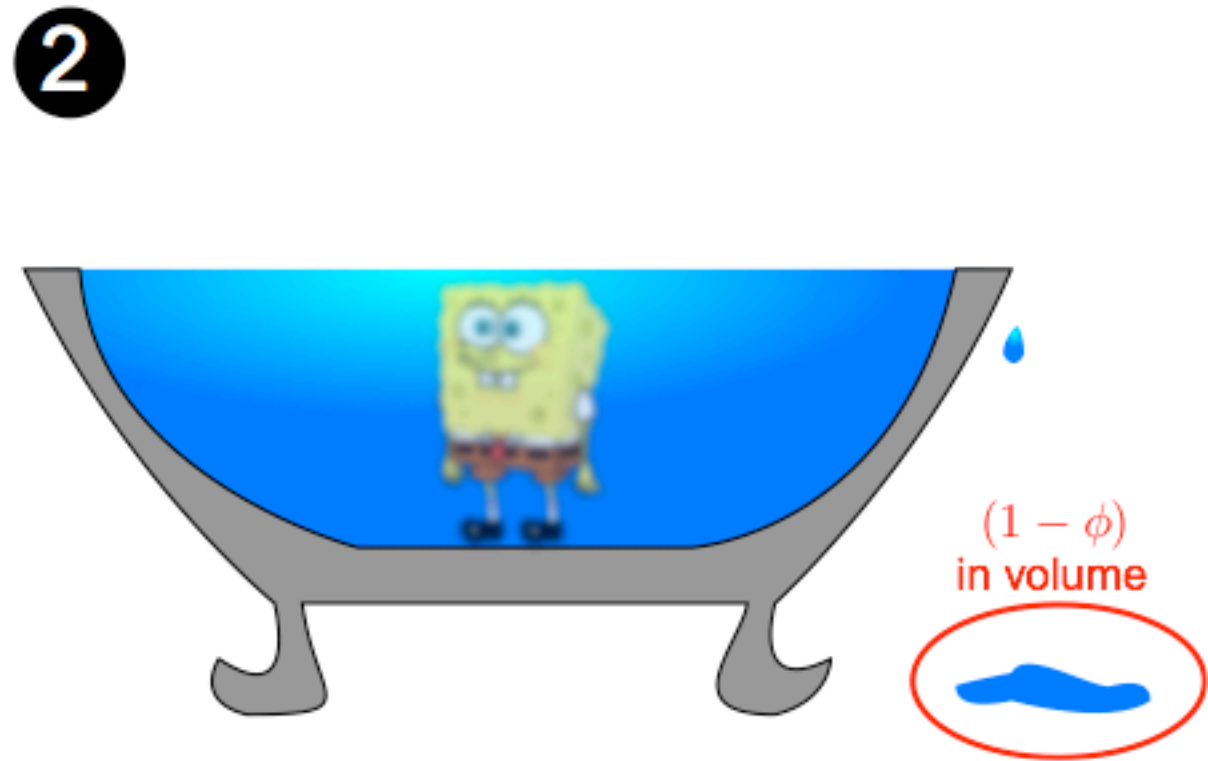
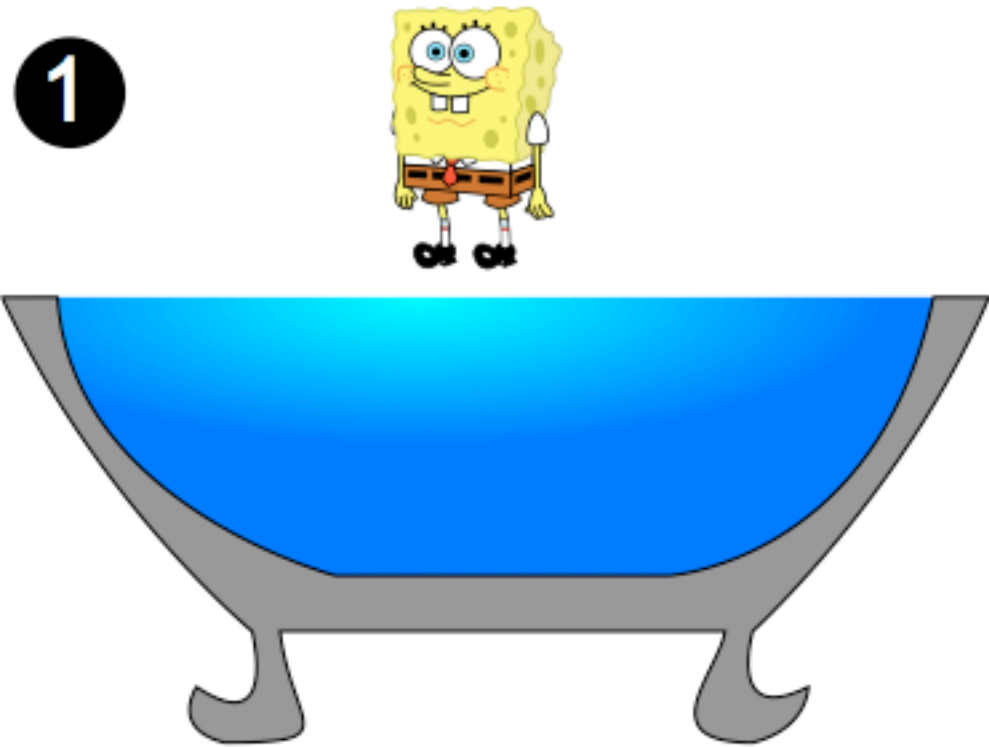

PROS

Accessible to everyone.

CONS

Low accuracy
(saturate the pore network is difficult)

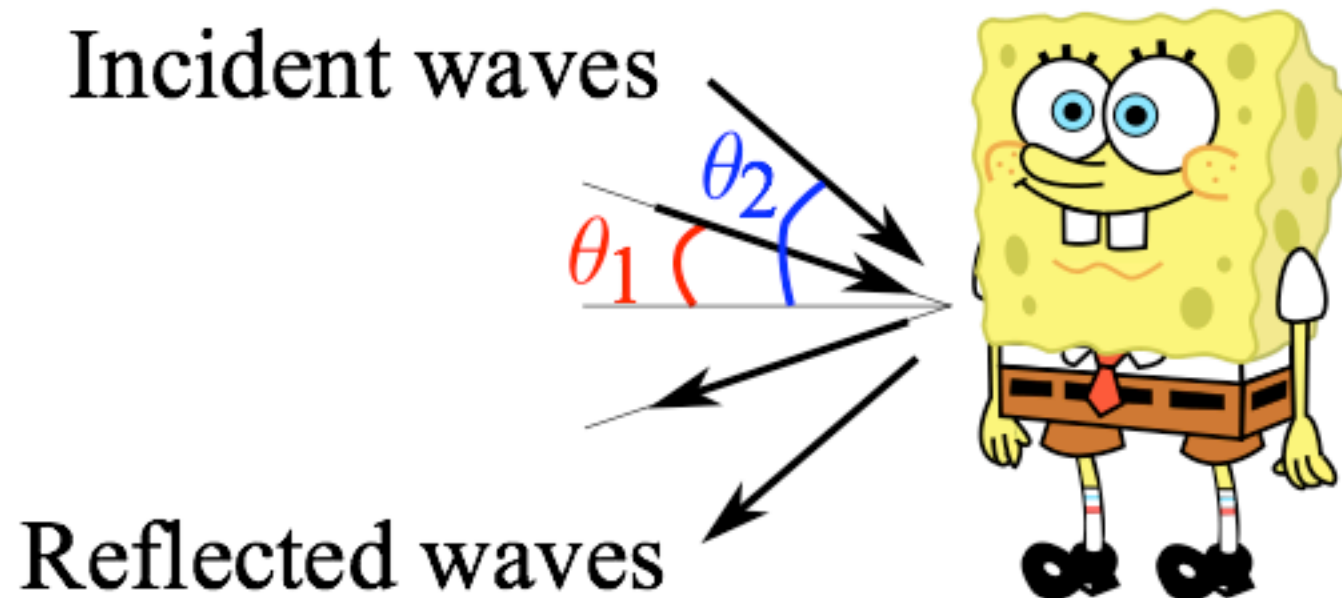

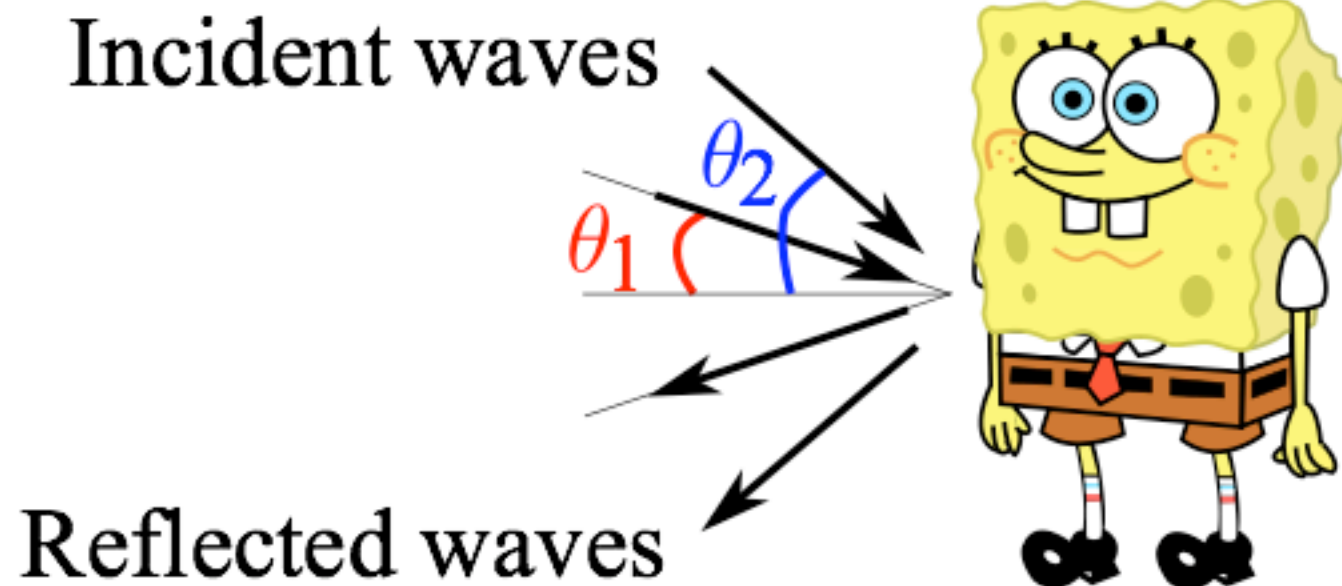
**PROS**

simultaneous estimation of tortuosity

CONS

Usuable on highly absorbing samples
(reflected waves approximated with first
interface ones)

$$\phi \simeq \frac{P_0}{\text{thickness} \times \omega} \quad \lim_{\omega \rightarrow 0} \left[\text{Im}(\text{Admittance}) \right]$$

$$\phi \simeq \frac{\rho_0 \alpha_\infty}{\lim_{\omega \rightarrow 0} \left[\text{Re}(\text{dynamic density}) \right]}$$

N. Selen 2003, Link: bibli.ec-lyon.fr

Bonfiglio & Pompili 2007, Link: www.materiacustica.it

$$\phi \simeq \frac{P_0}{\text{thickness} \times \omega} \quad \lim_{\omega \rightarrow 0} \left[\text{Im}(\text{Admittance}) \right]$$

$$\phi \simeq \frac{\rho_0 \alpha_\infty}{\lim_{\omega \rightarrow 0} \left[\text{Re}(\text{dynamic density}) \right]}$$

PROS

Quick way for an estimation

CONS

Low accuracy or inconsistent results

Static air flow resistivity

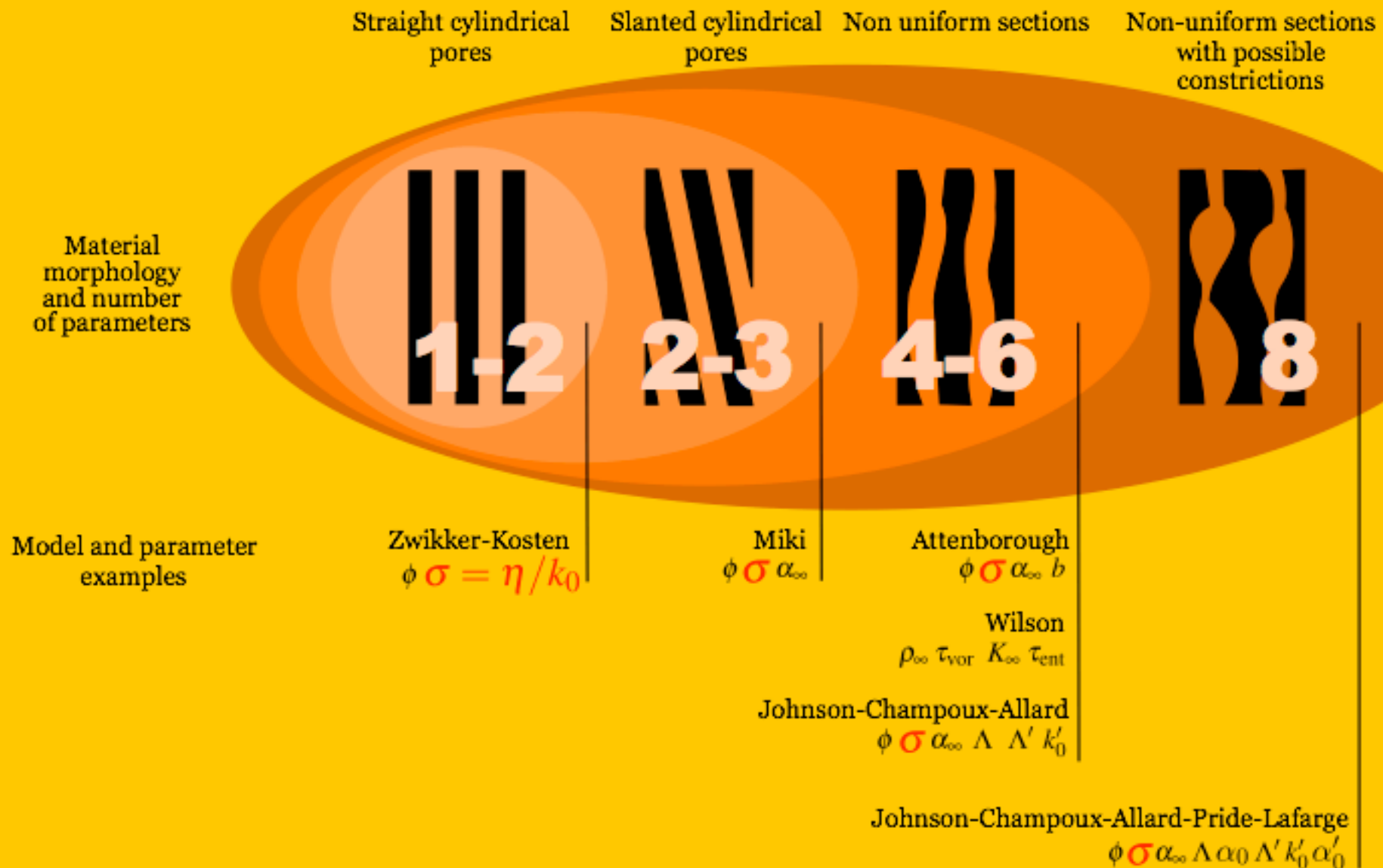

Static air flow resistivity

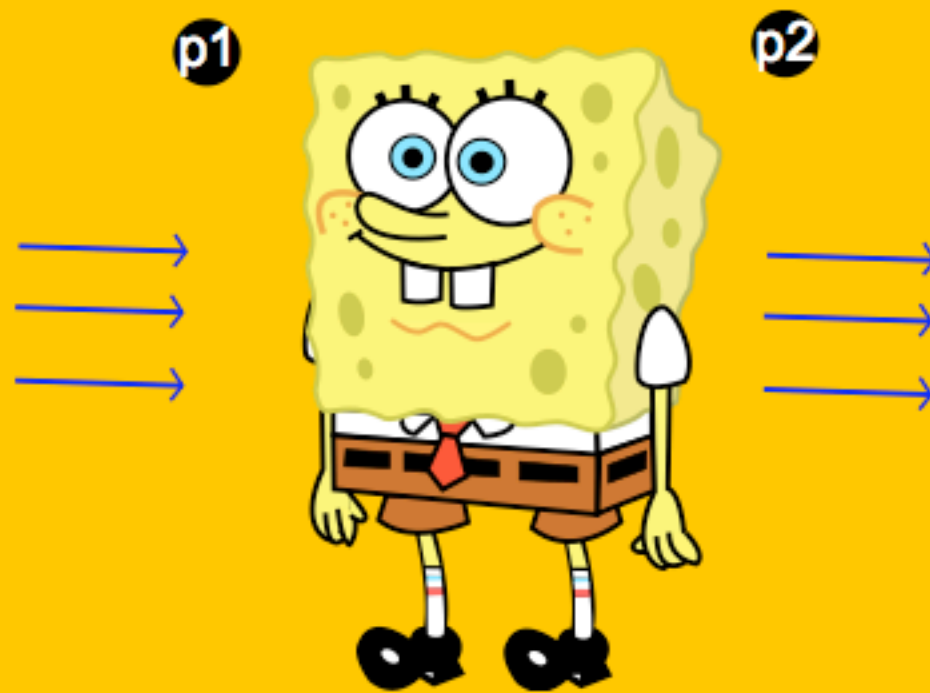

$$\phi \vec{v} = - \frac{1}{\sigma} \vec{\nabla} p$$

Range of values:

$$[0 \quad - \quad +\infty [\quad \text{N.s.m}^{-4}$$

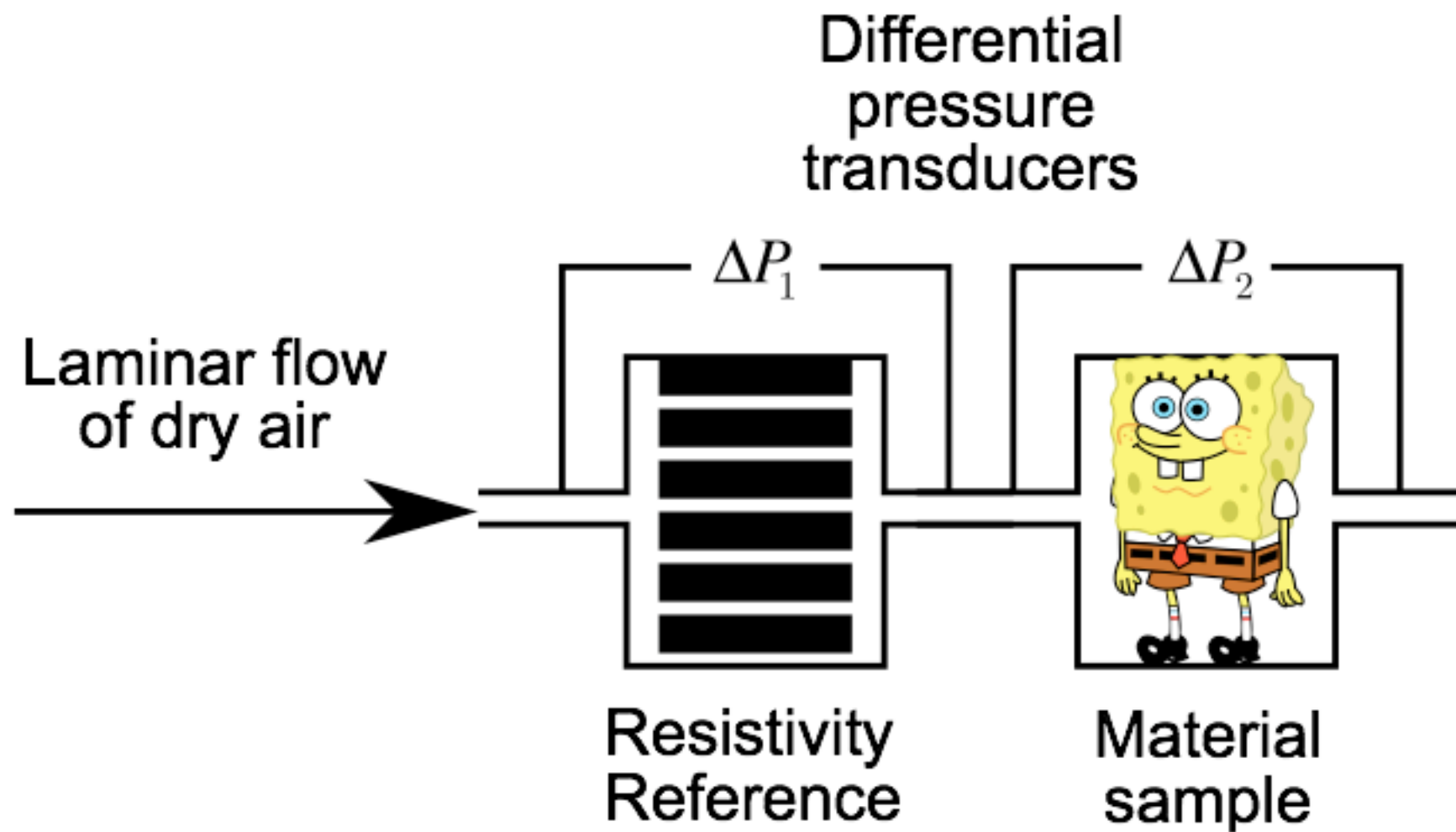

ACOUSTIC **Static air flow resistivity > Pressure difference**

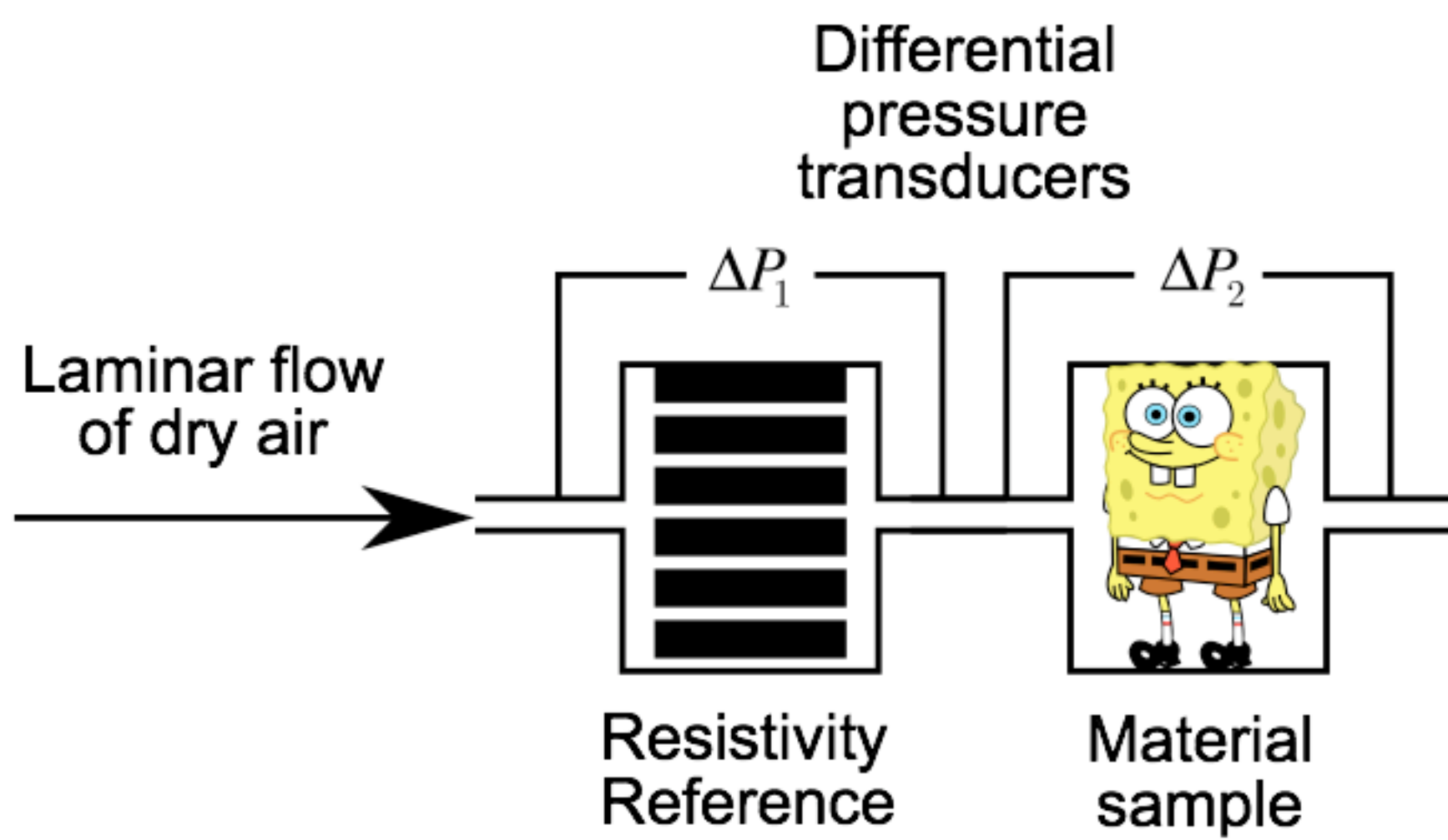

PROS	CONS
Direct measurement	Boundary conditions can impact results

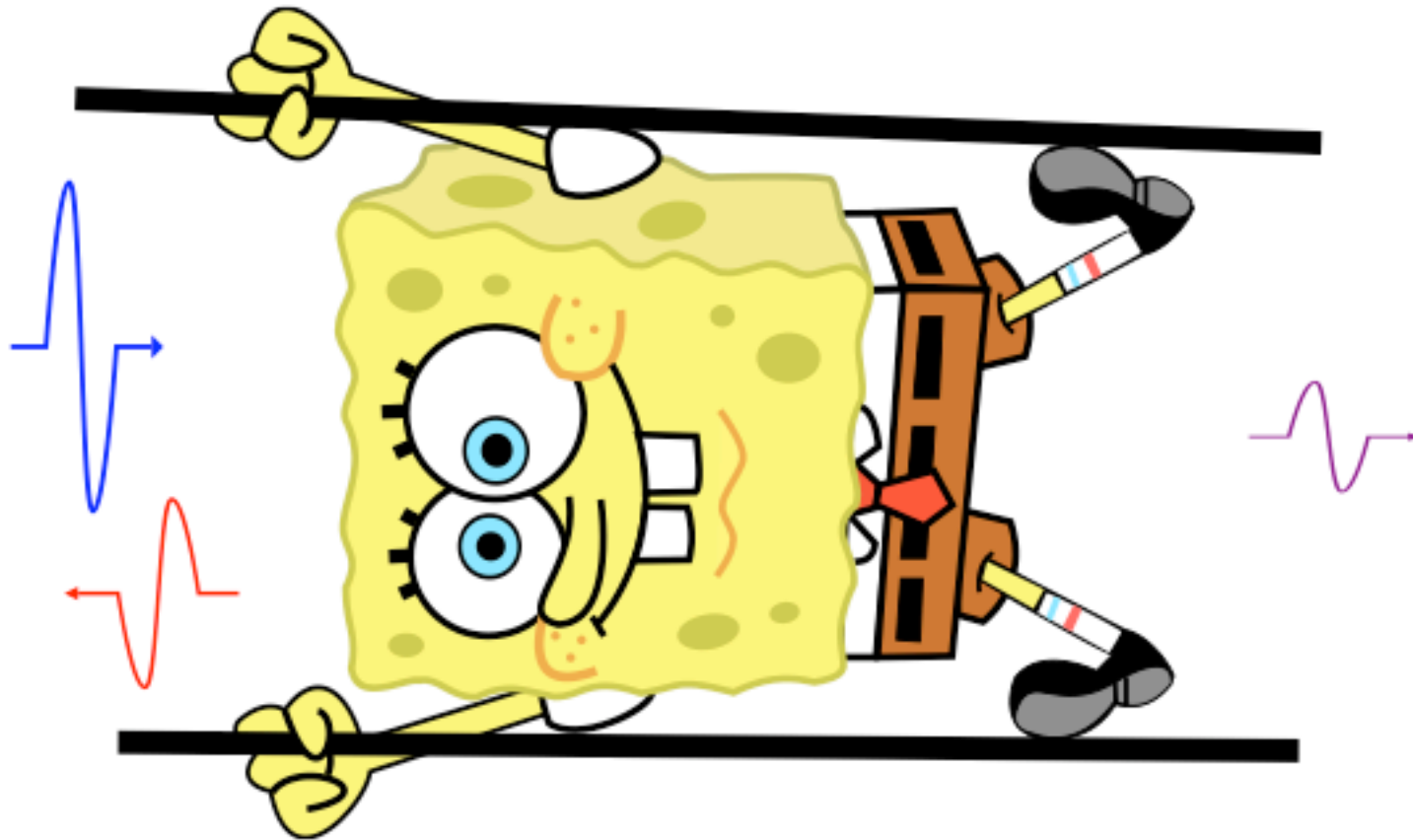

Sebaa et al. 2005, DOI: 10.1063/1.2099510

Fellah et al. 2006, DOI: 10.1121/1.2179749

ACOUSTIC

Static air flow resistivity > Pulse reflection or transmission

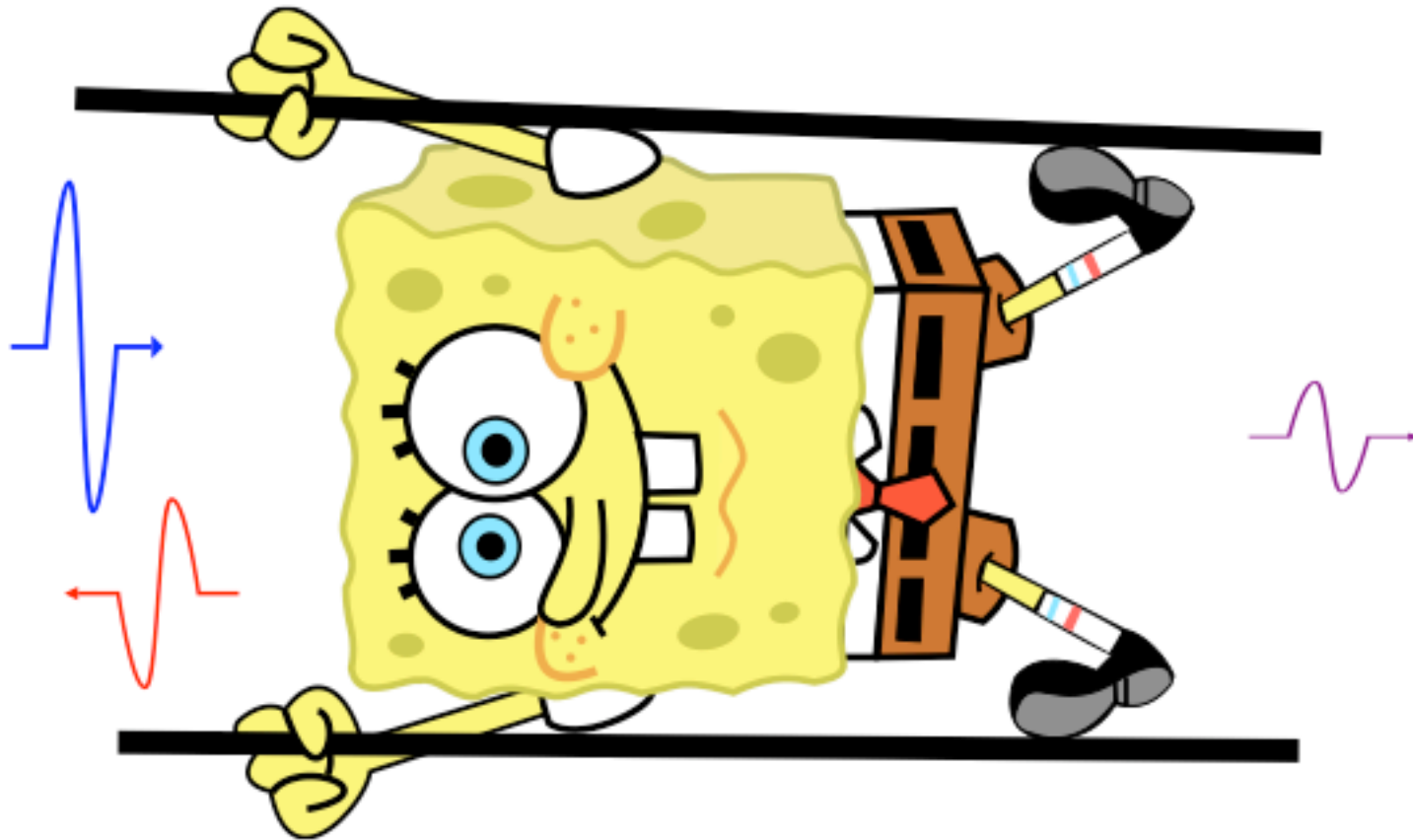

PROS

Closer to the actual conditions of use

CONS

Numerical inversions are used
(requiring a priori information)

ACOUSTIC

Static air flow resistivity > Low freq. asymptote of $\text{Im}(\tilde{\rho})$

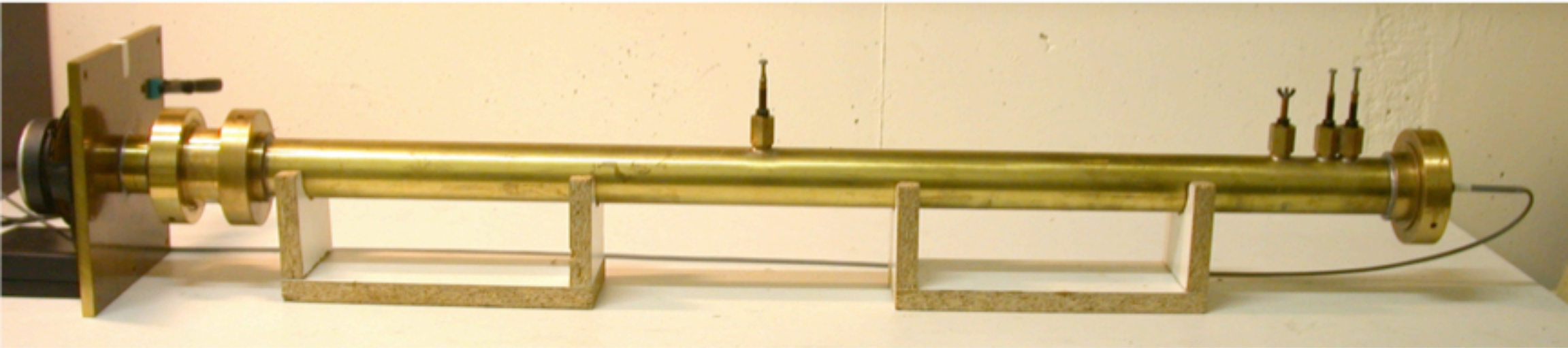

Set-up at ENTPE

ACOUSTIC

Static air flow resistivity > Low freq. asymptote of $\text{Im}(\tilde{\rho})$

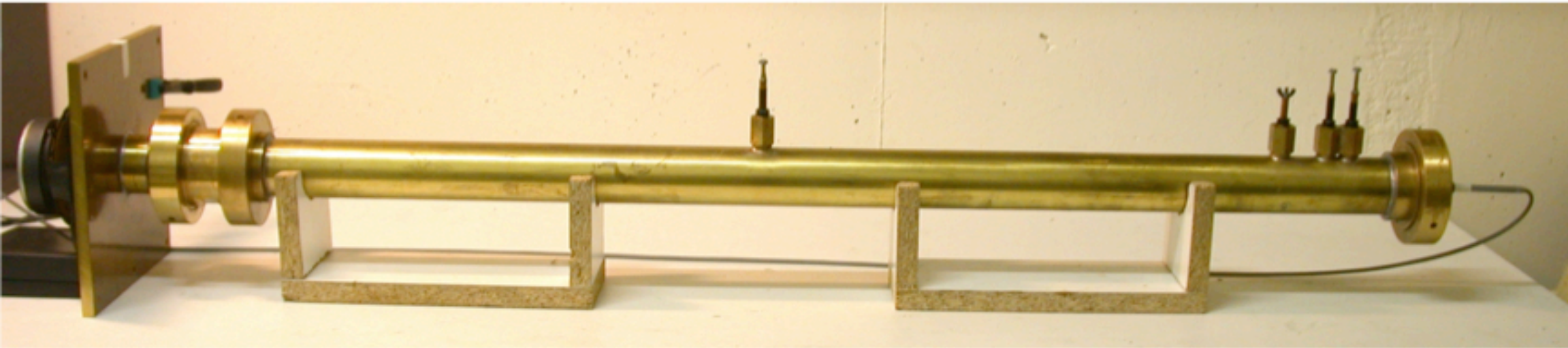

Set-up at ENTPE

PROS

Measurements at audible frequencies.

CONS

Asymptote can be difficult to identify.

High freq. limit of dynamic tortuosity

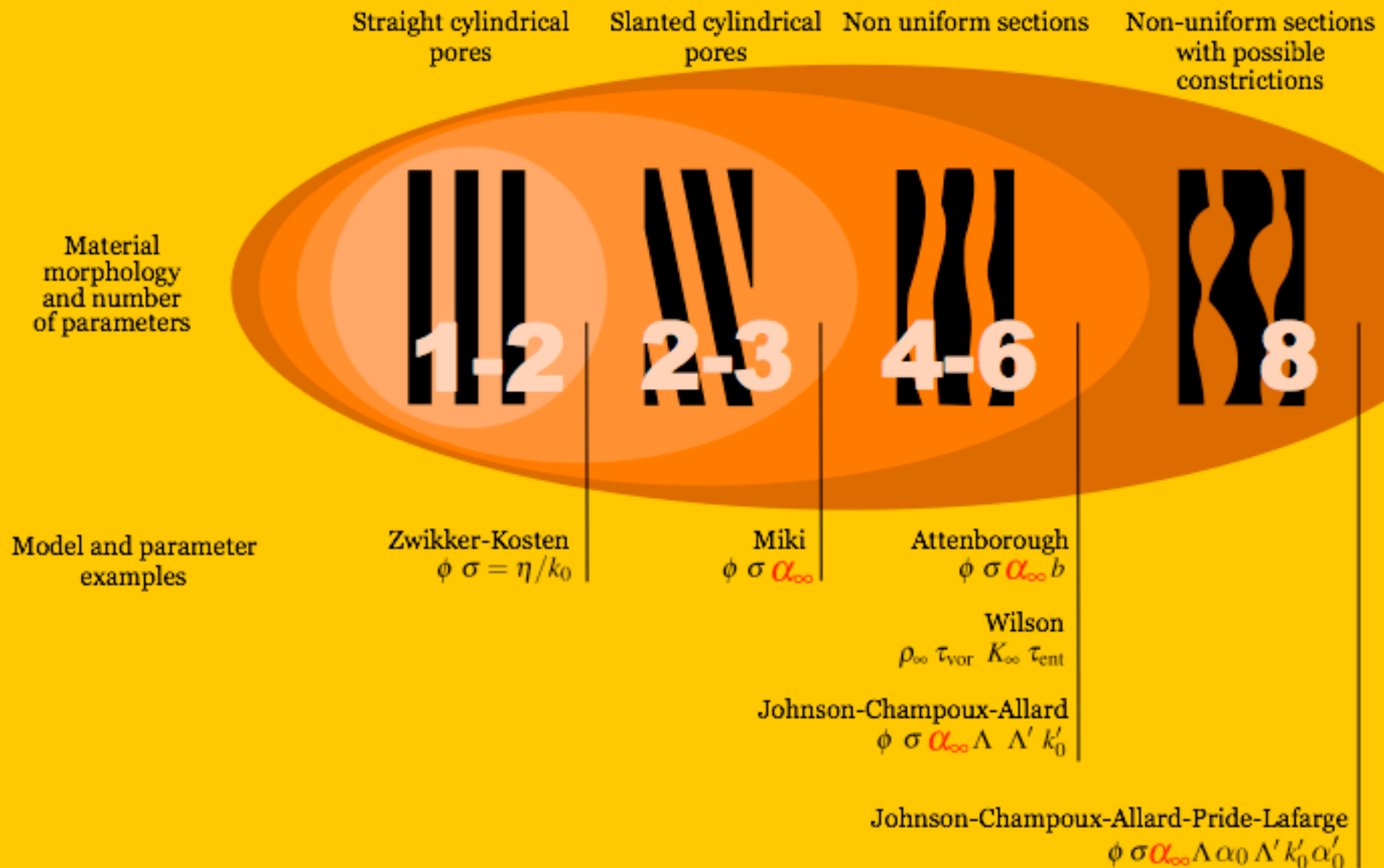

HF limit of the dynamic tortuosity

"We shall consider the value of α_∞ to be a measure of the disorder in the system."

D. L. Johnson, J. Koplik, R. Dashen

Range of values:

[1 — 3]

ACOUSTIC

HF limit of dynamic tortuosity > Electric liquid saturation

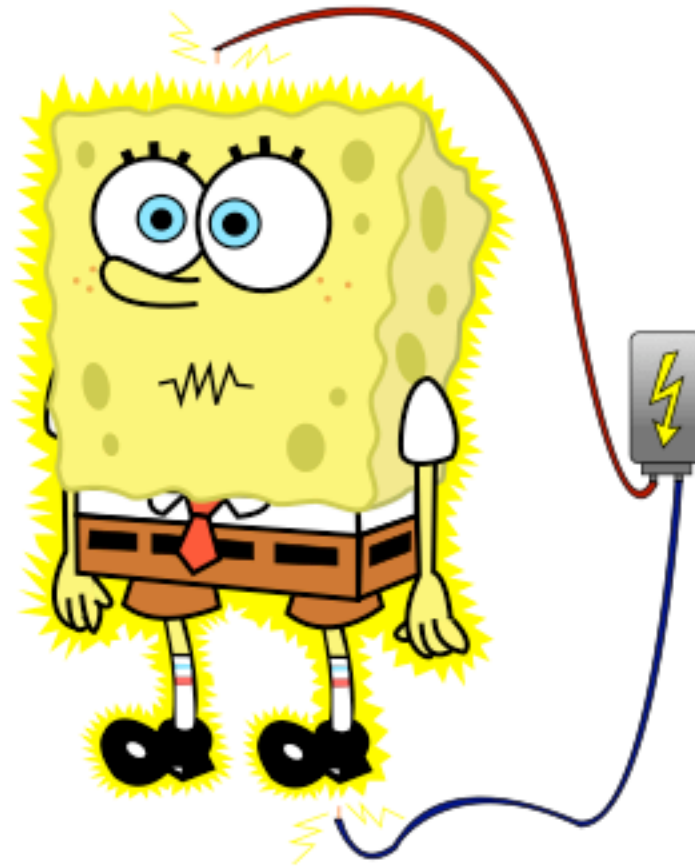

R. J. S. Brown 1980, DOI: 10.1190/1.1441123

Johnson et al. 1982, DOI: 10.1103/PhysRevLett.49.1840

ACOUSTIC

HF limit of dynamic tortuosity > Electric liquid saturation

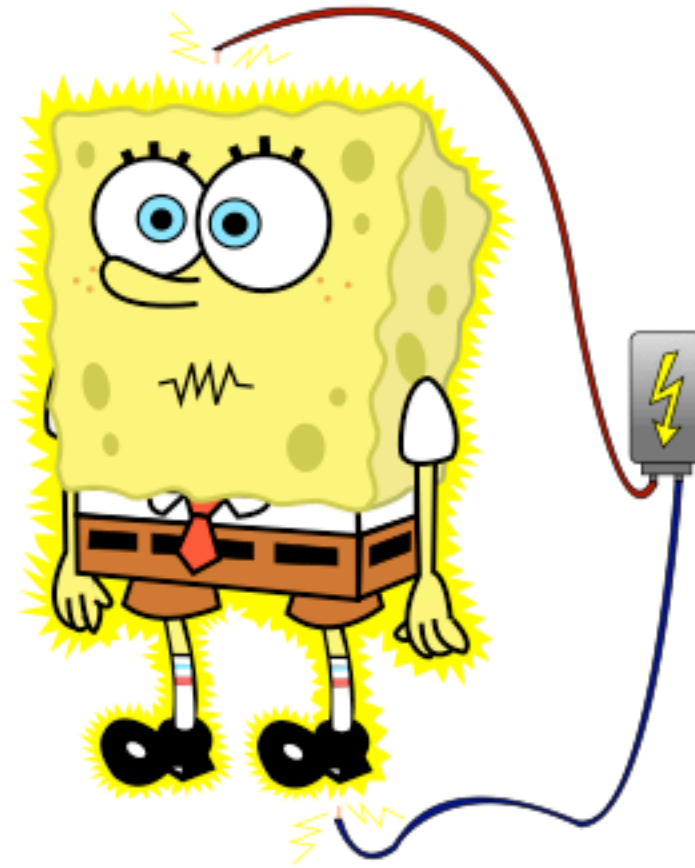

PROS

Direct measurement.

CONS

Skeleton must be an electrical insulator.
Open-porosity is required.

- Ultrasound waves:

Give estimations for α_∞ and $\Lambda, \Lambda', (\phi)$

- Impedance tube:

Give estimations for α_∞ and k'_0, Λ, Λ'

Static thermal permeability + Viscous & thermal characteristic lengths

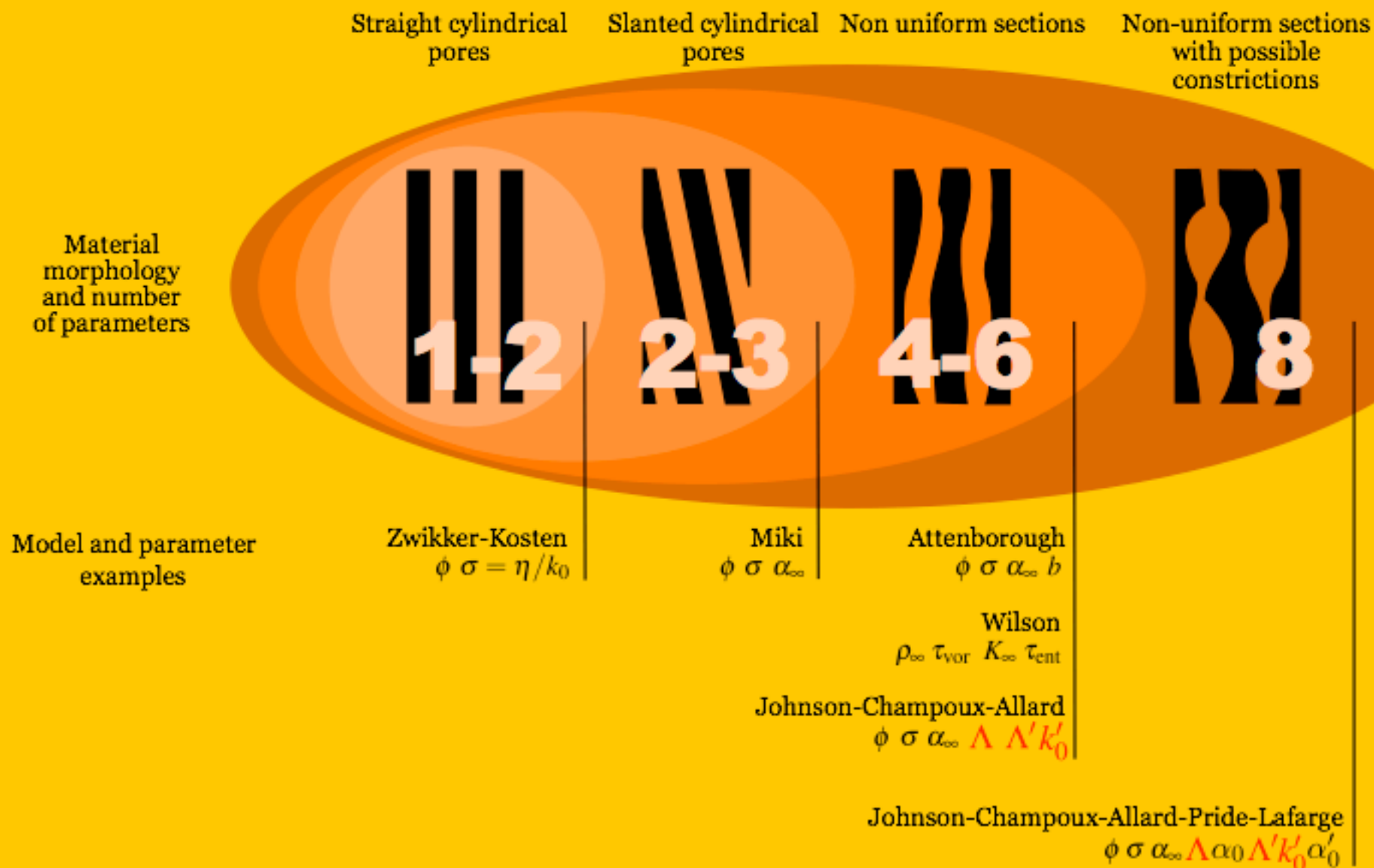

Static thermal permeability

t1



t2



$$\phi\tau = k'_0 \alpha \frac{\partial p}{\partial t}$$

Range of values:

$$[0 \quad - \quad +\infty [m^2$$

$$\text{with } k'_0 \geq k_0$$

Viscous & thermal characteristic lengths

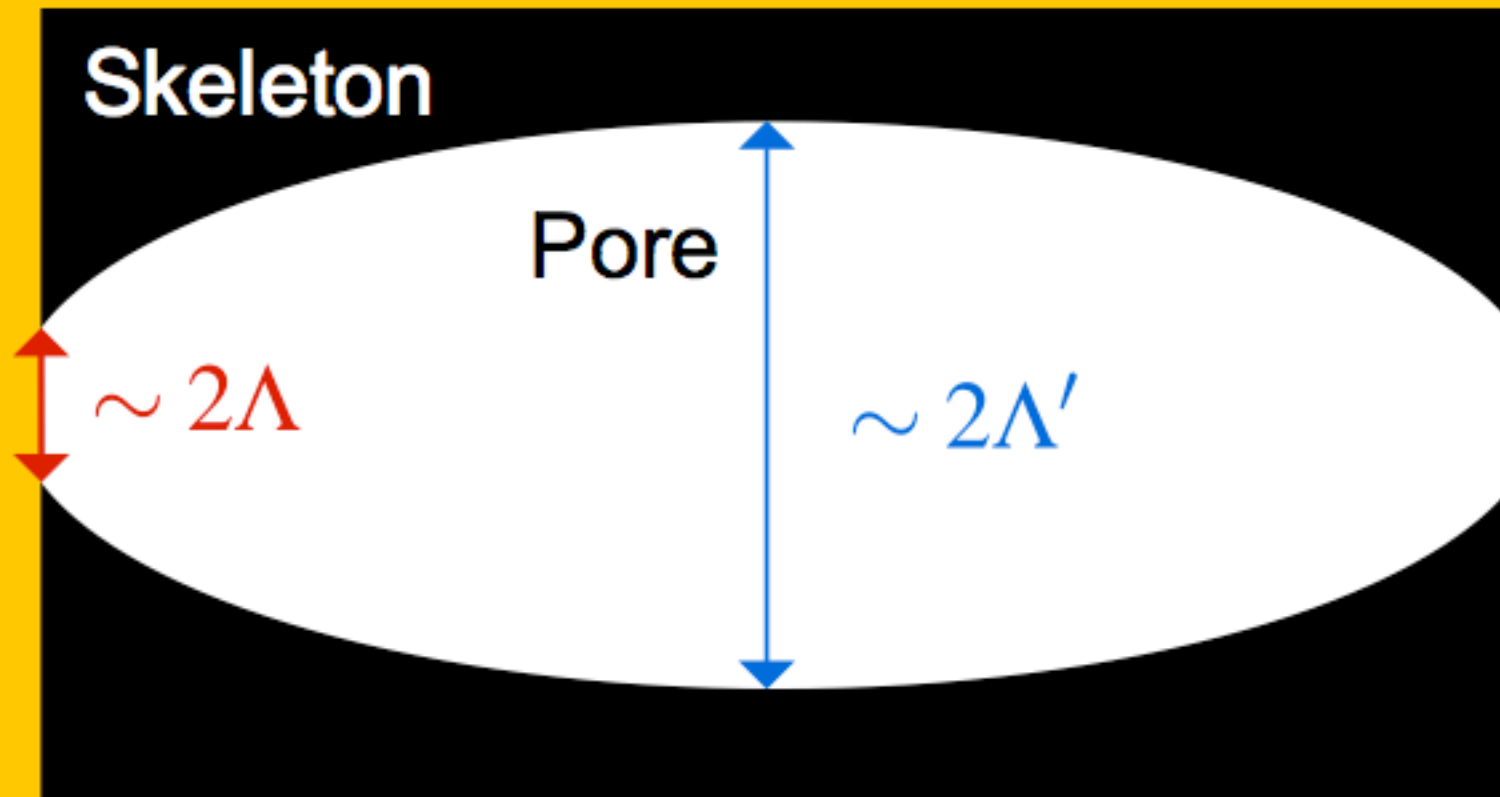

Range of values:
[10 — 1 000] μm
($\Lambda \leq \Lambda'$)

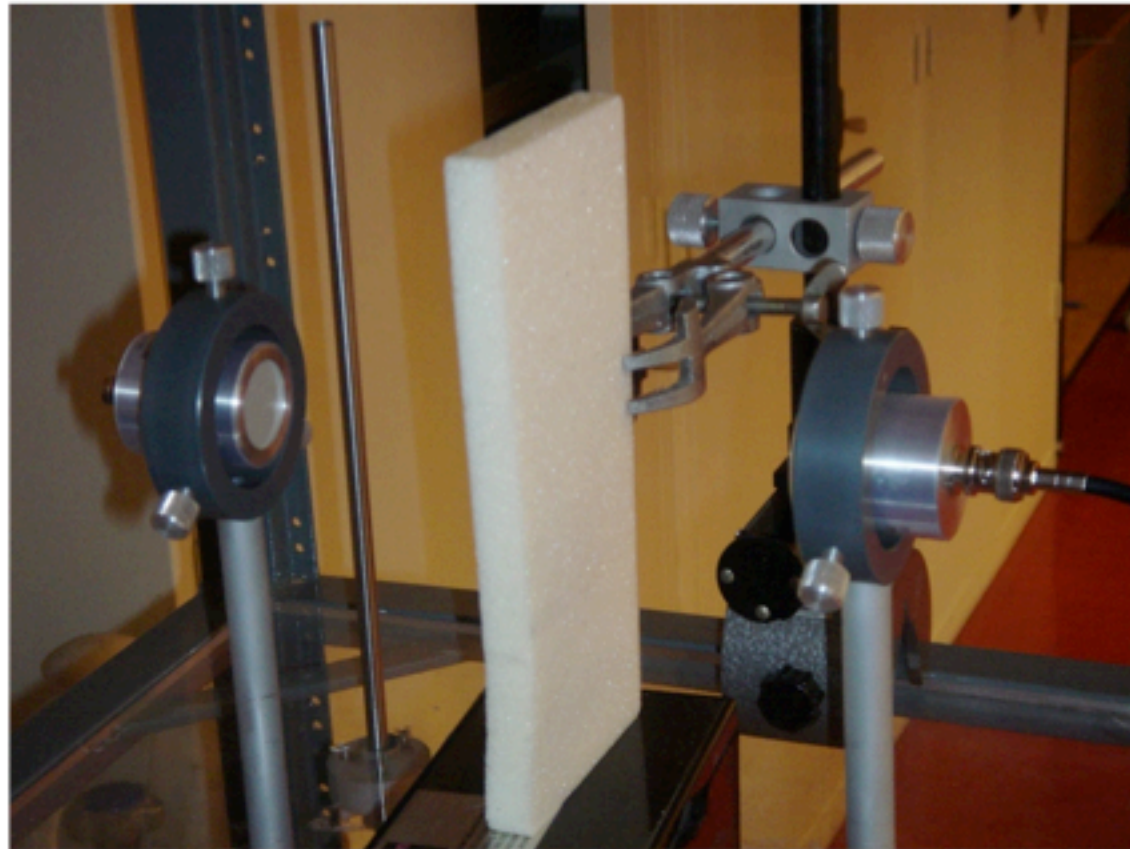

Picture courtesy of W. Lauriks

Allard et al. 1994, DOI: 10.1063/1.1145097

Leclaire et al. 1996, DOI: 10.1121/1.415378

Leclaire et al. 1996, DOI: 10.1063/1.363817

Groby et al. 2010, DOI: 10.1121/1.3283043

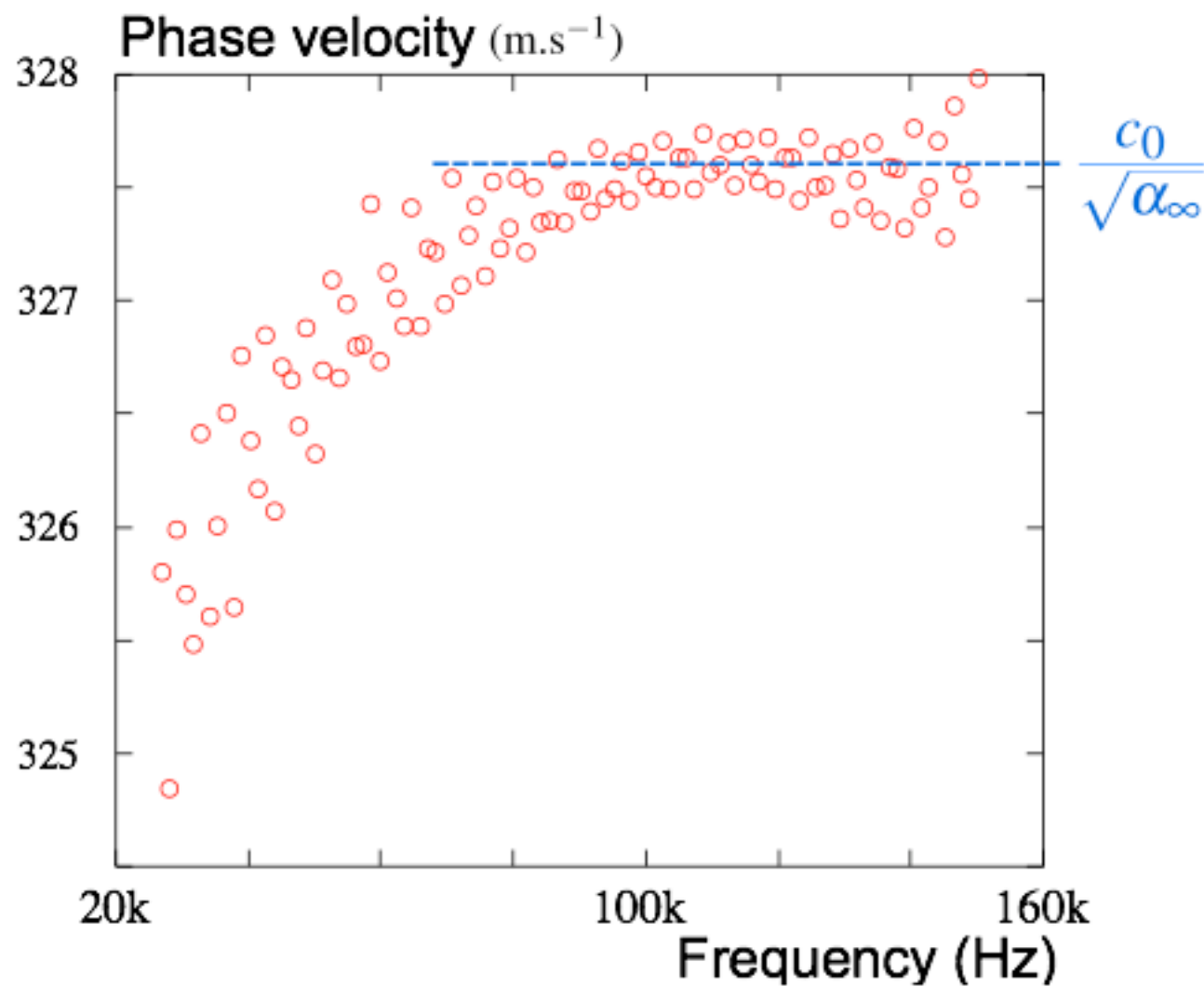
**PROS**

Can quickly mapped heterogeneity

CONS

Multiple scattering can occur
(measurements with 2 fluids thus needed)

ACOUSTIC

$\alpha_\infty, \Lambda, \Lambda', k'_0 >$ Impedance tube

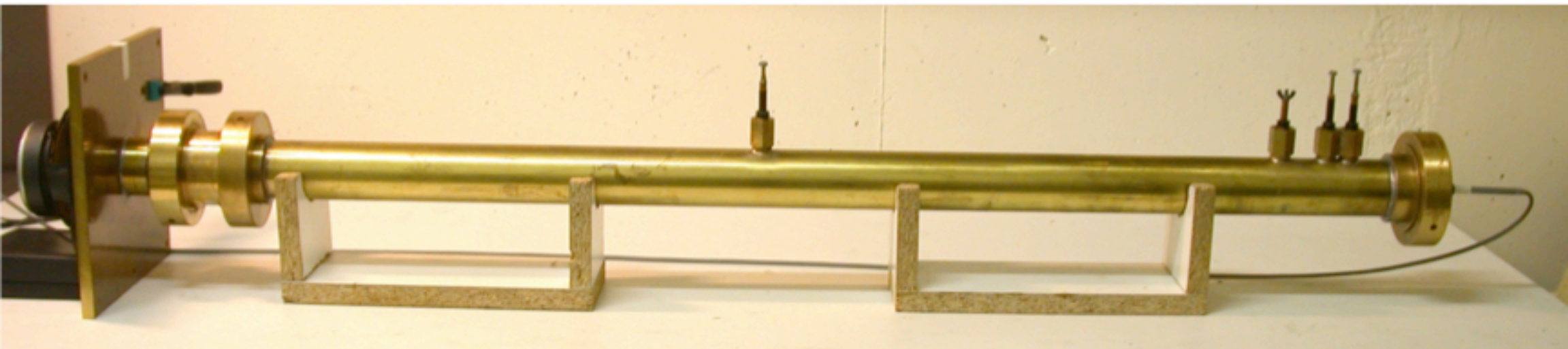

Set-up at ENTPE

Panneton & Olny 2006, DOI: 10.1121/1.2169923

Olny & Panneton 2008, DOI: 10.1121/1.2828066

ACOUSTIC

$\alpha_\infty, \Lambda, \Lambda', k'_0 >$ Impedance tube

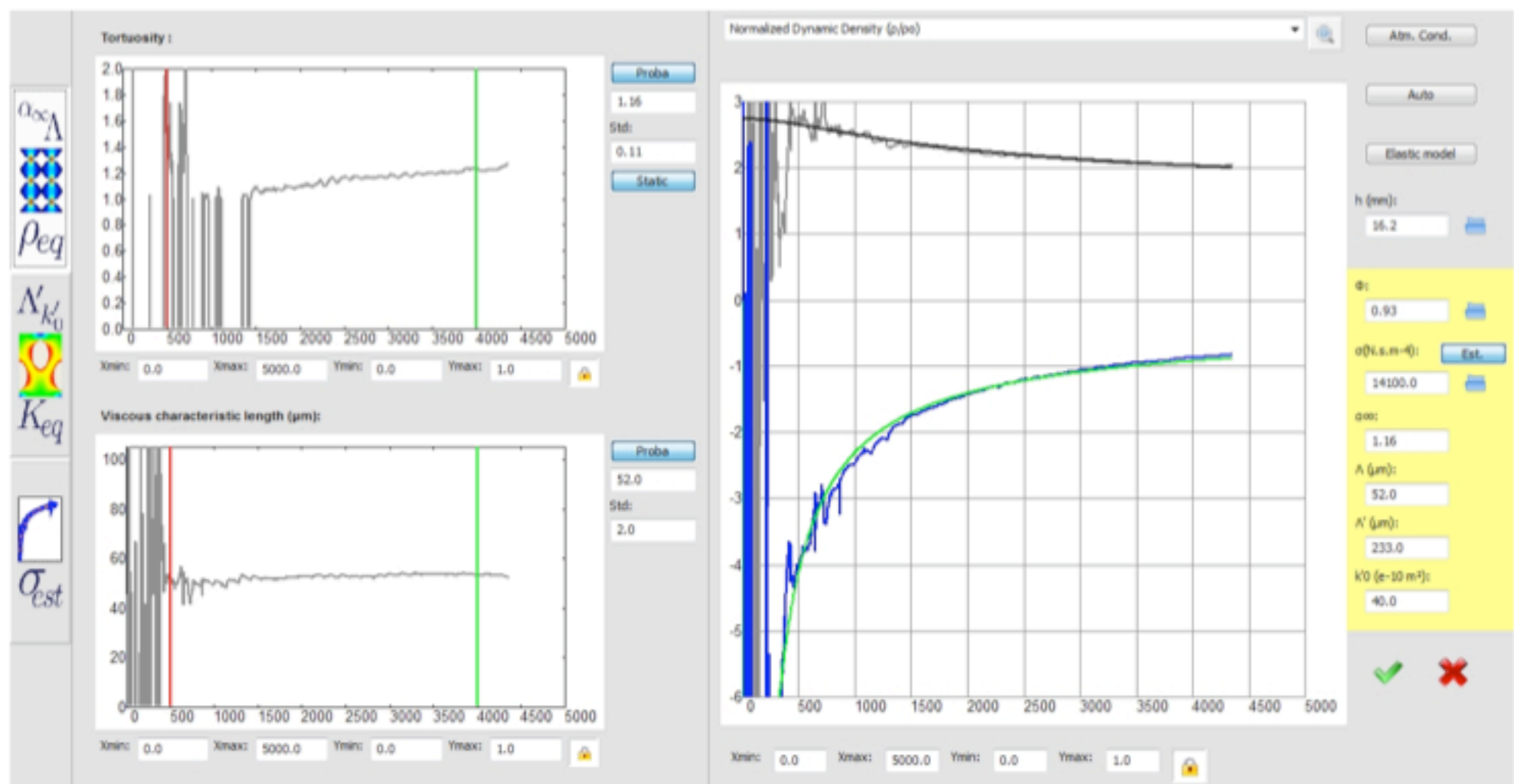

PROS CONS

Measurements at audible frequencies.
Analytical inversions (no fit).

Porosity and resistivity must be known.
Sensible to frame vibrations, air leakages.

Static tortuosities



Pore size distribution

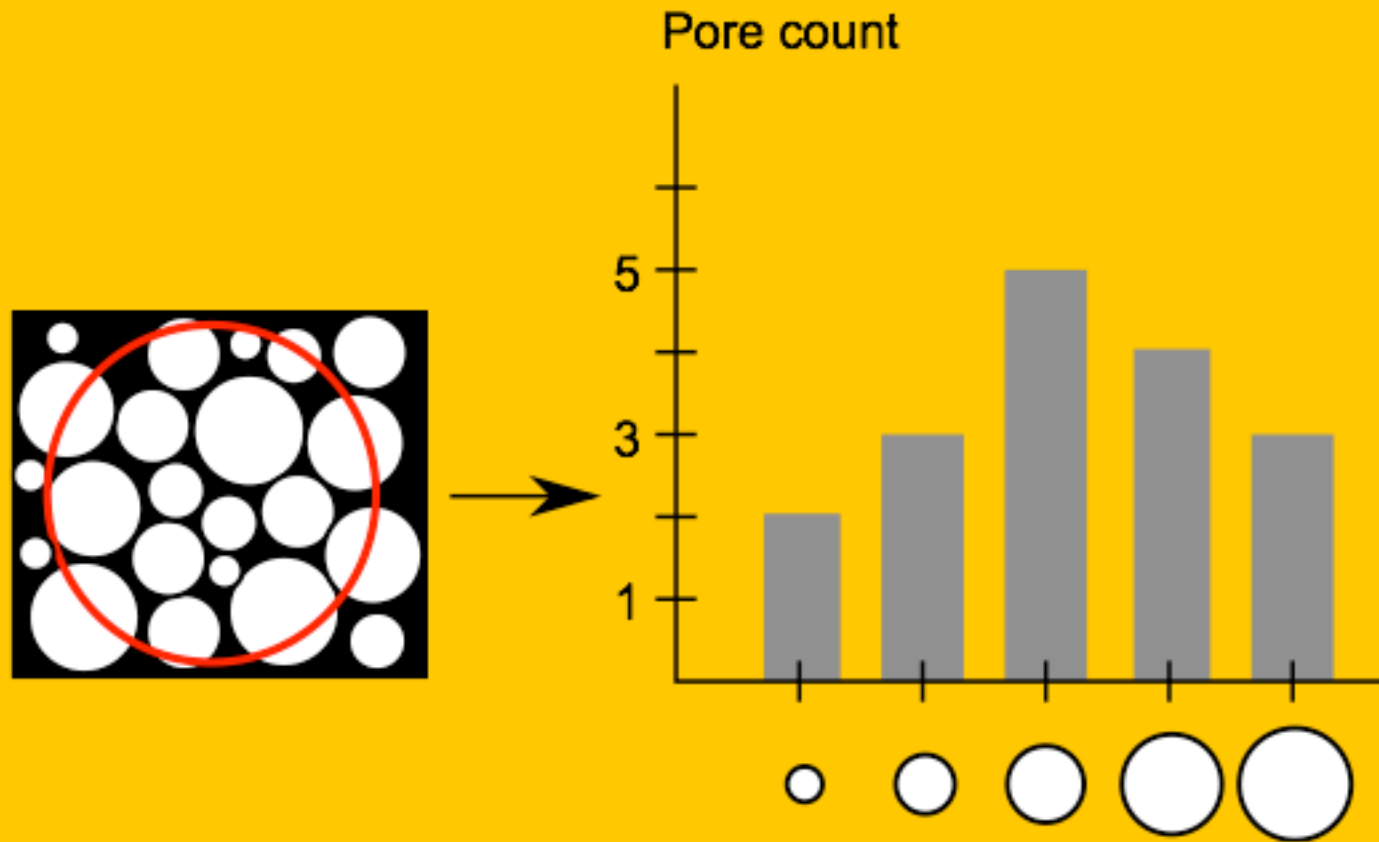

Two methods:

- optical analysis of 2D images or 3D tomography acquisitions,
- mercury intrusion.

A note about perforated facings

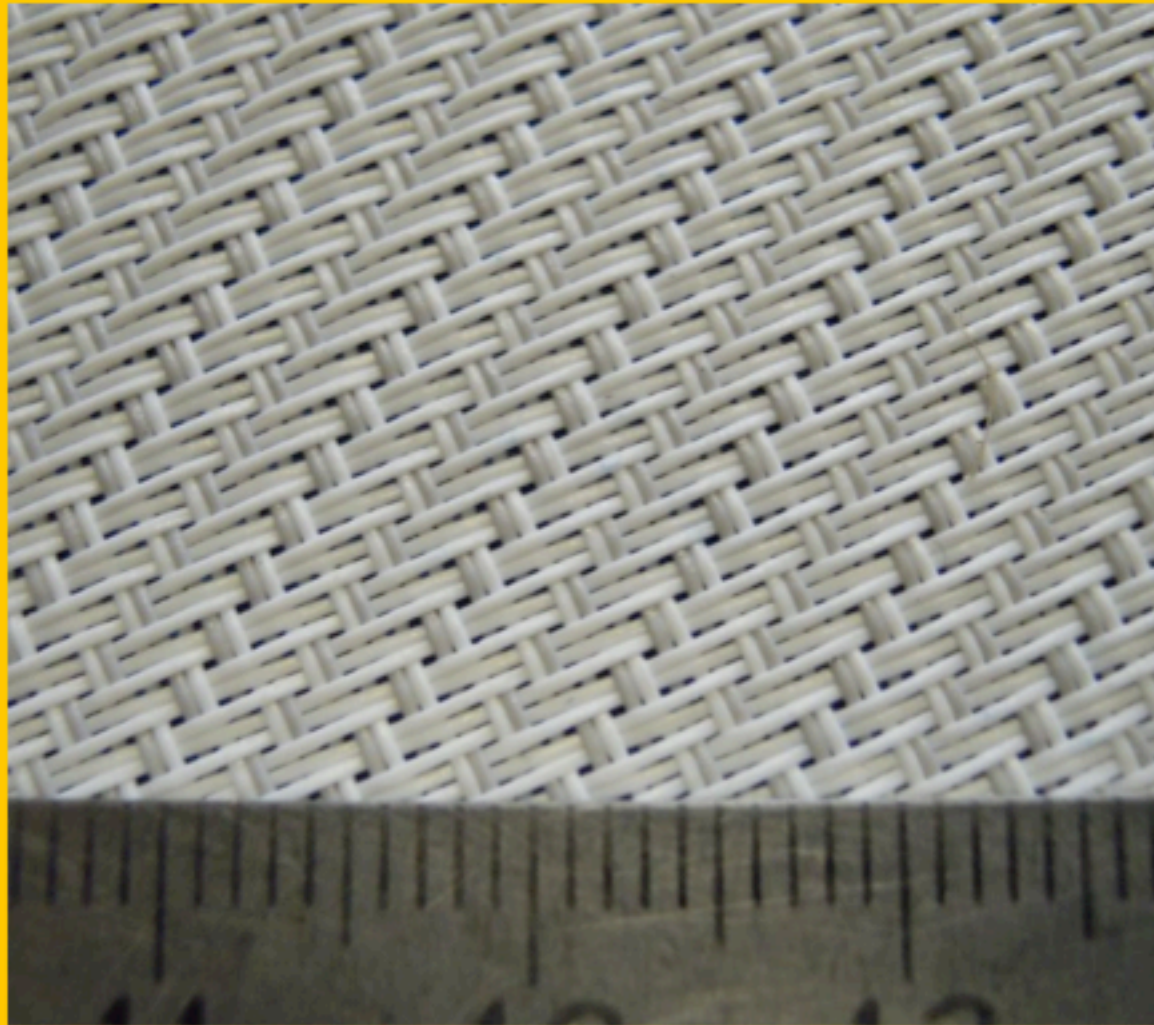

VISCO-ELASTIC Characterization



Linear elastic domain

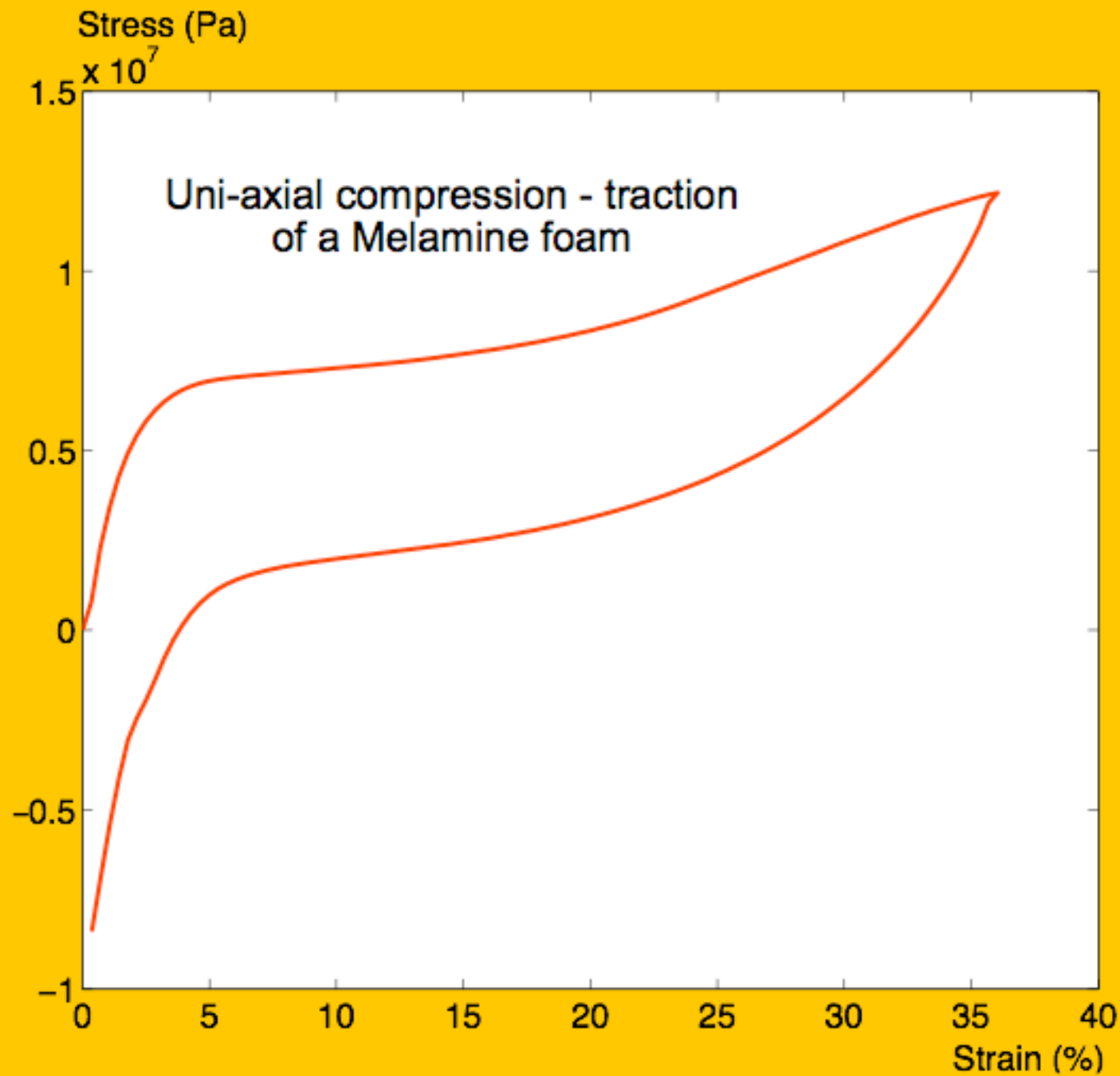

Characterization strategies

1. Quasi-static measurements at different temperatures

and use of Time-Temperature Superposition principle

+: Low coupling between phases at low frequencies (< 100 Hz)

2. Dynamic measurements

(and eventually use of TTS principle)

+: Estimation in the audible frequency range (~ 100 to $10\,000$ Hz).

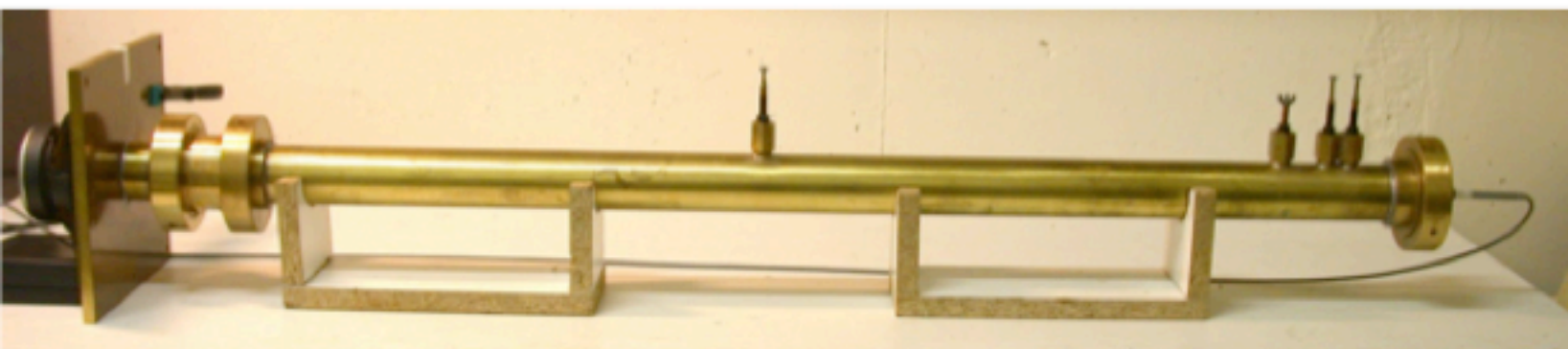
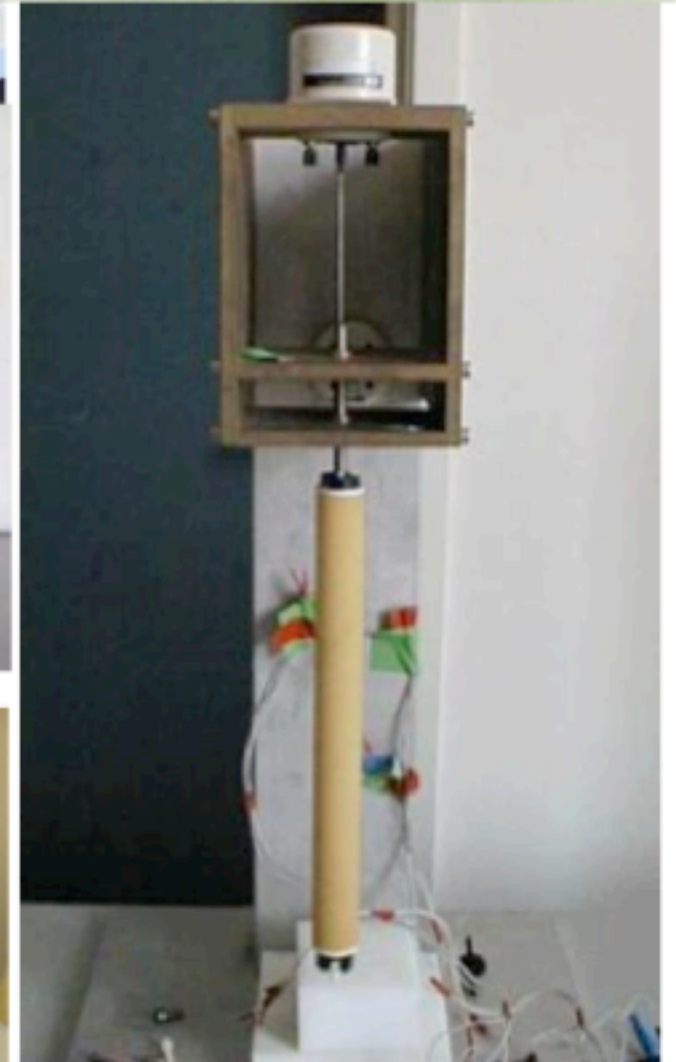
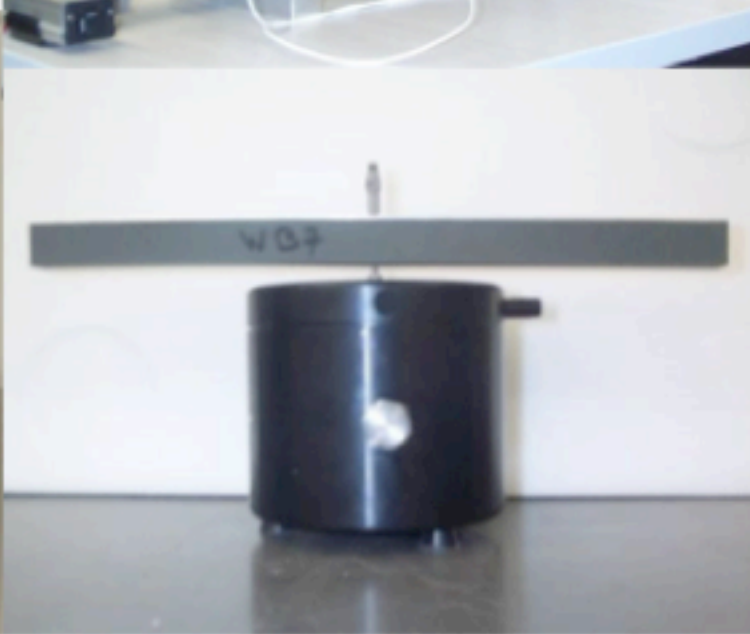
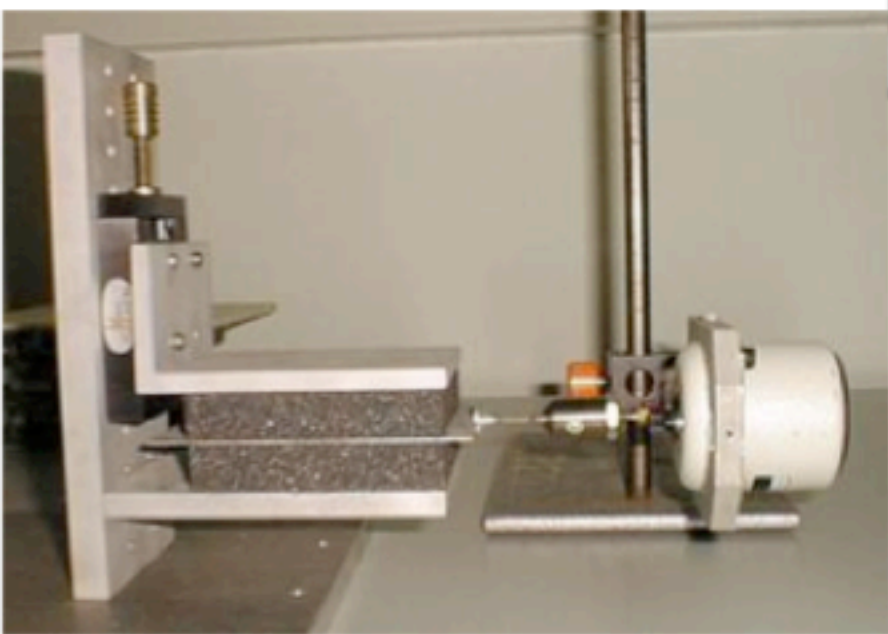
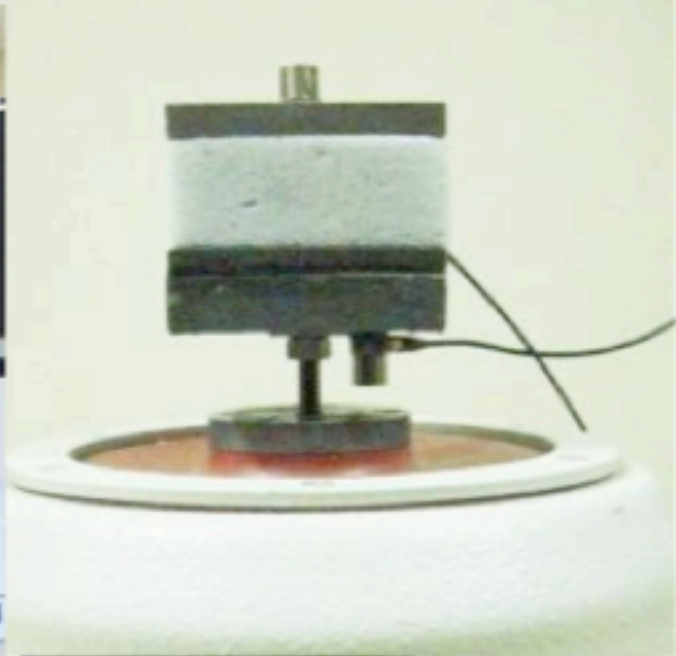
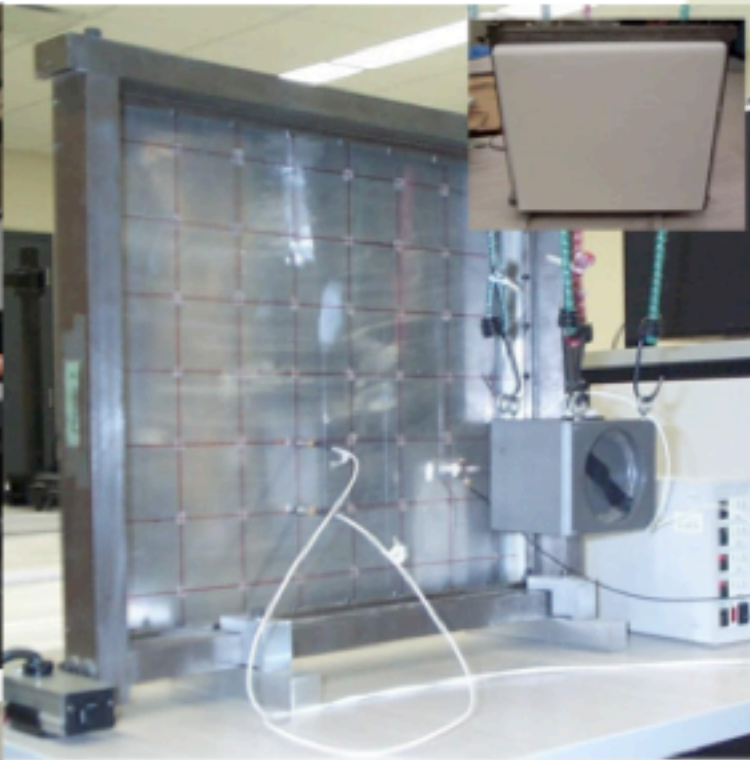
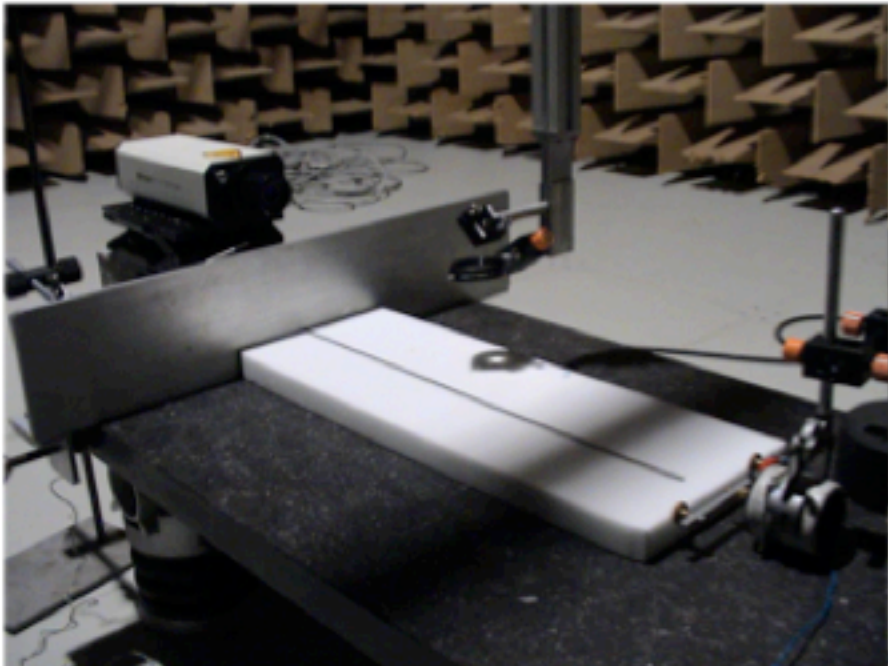

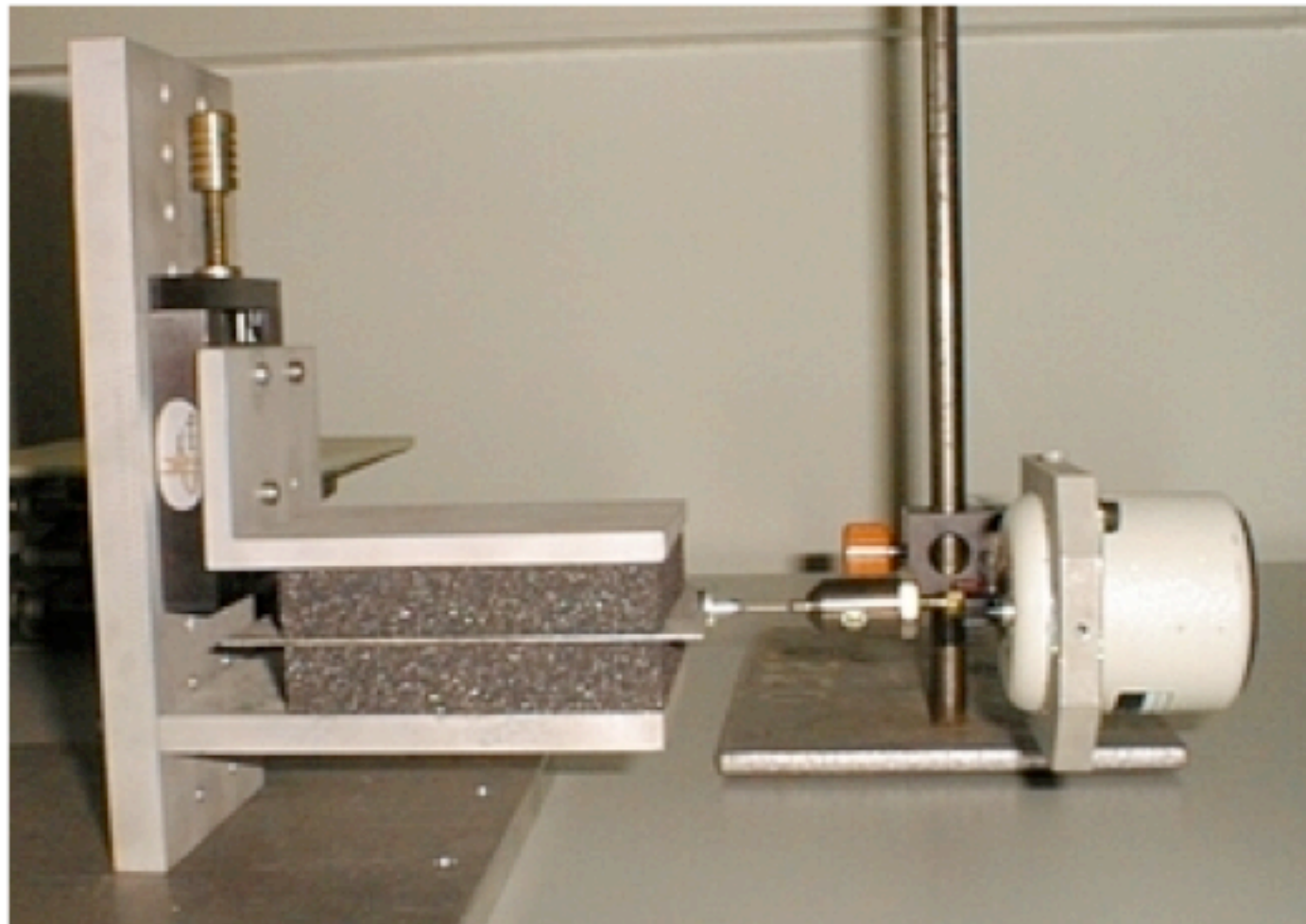

Picture courtesy of W. Lauriks

Etchessahar et al. 2005, DOI: 10.1121/1.1857527

V. Tarnow 2005, DOI: 10.1121/1.2118267

Jaouen et al. 2008, DOI: 10.1016/j.apacoust.2007.11.008

VISCO-ELASTIC Shear modulus

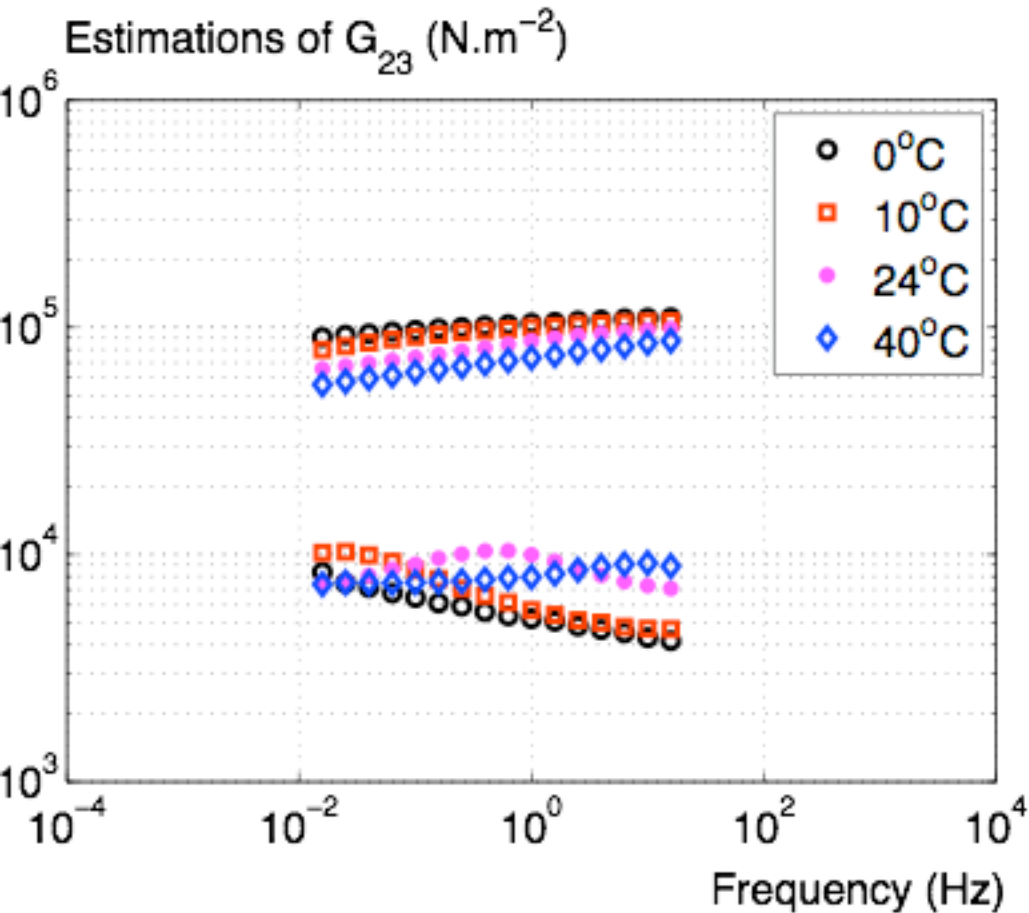

TTS

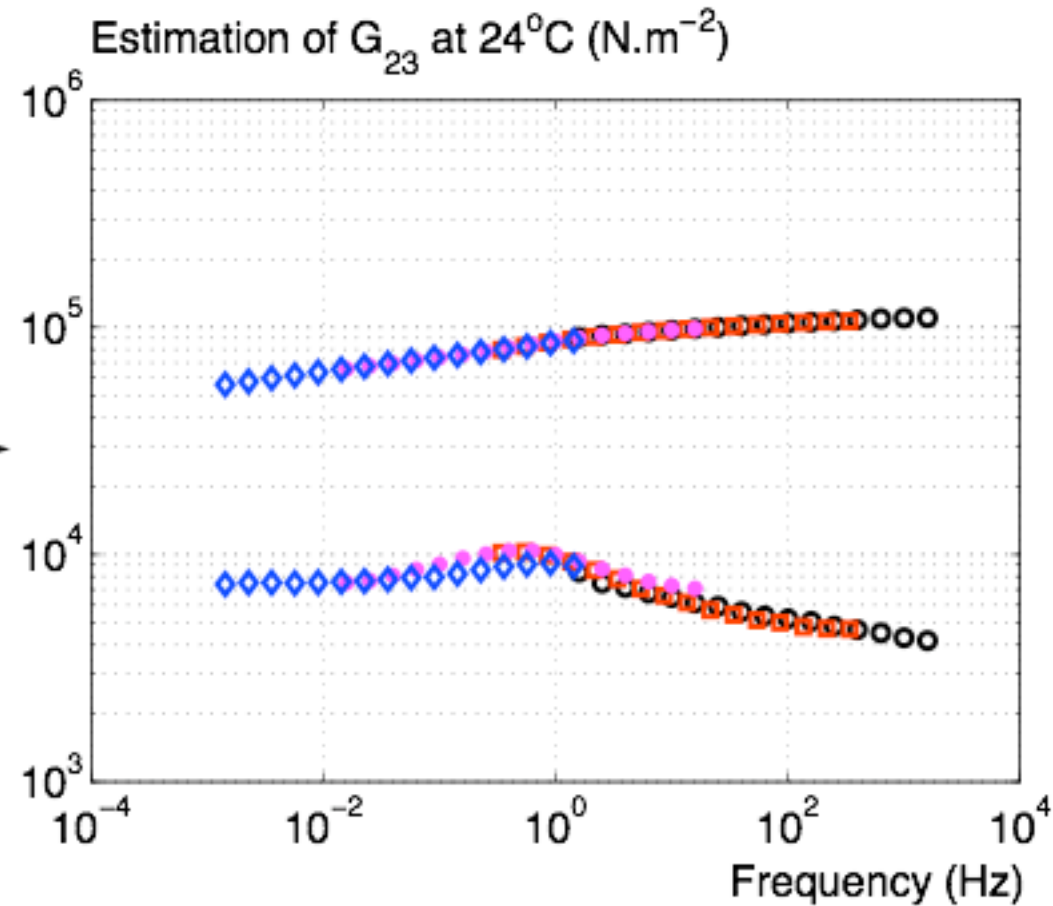

PROS

Low coupling between phases
(no change in volume, no shear in fluid).

CONS

No coupling taken into account in model.

VISCO-ELASTIC Shear modulus

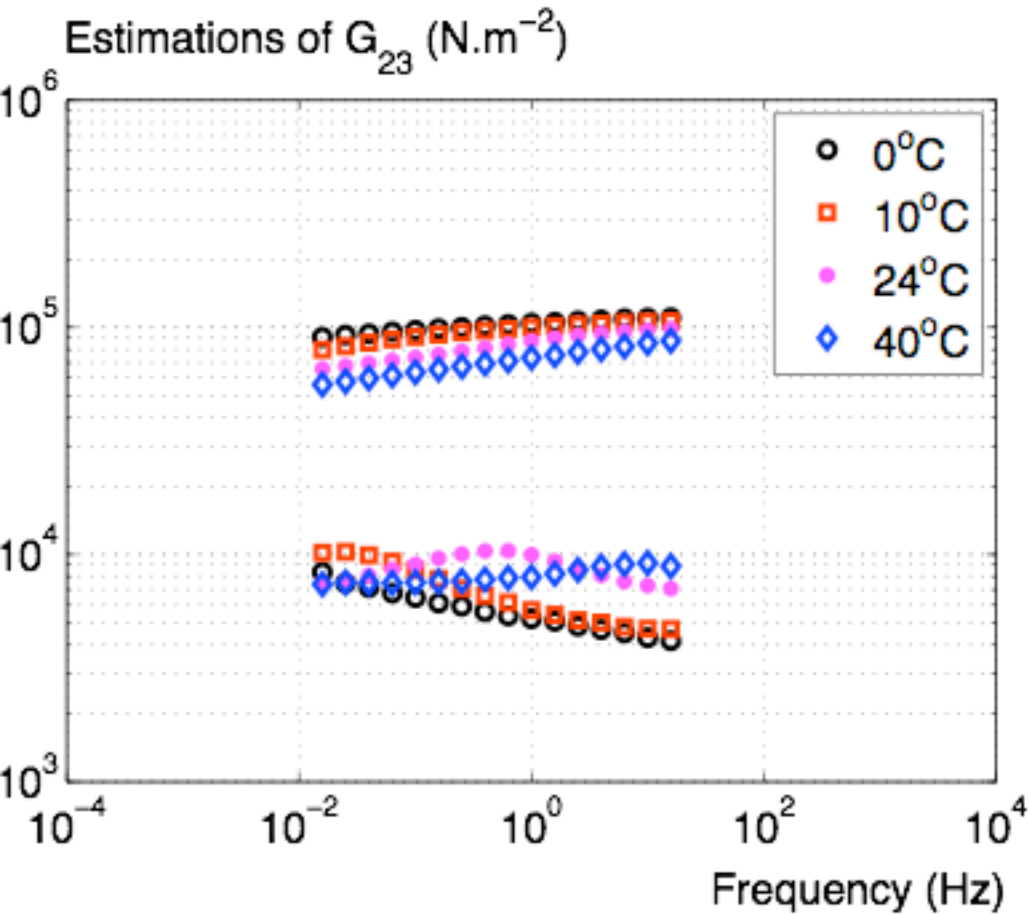

TTS

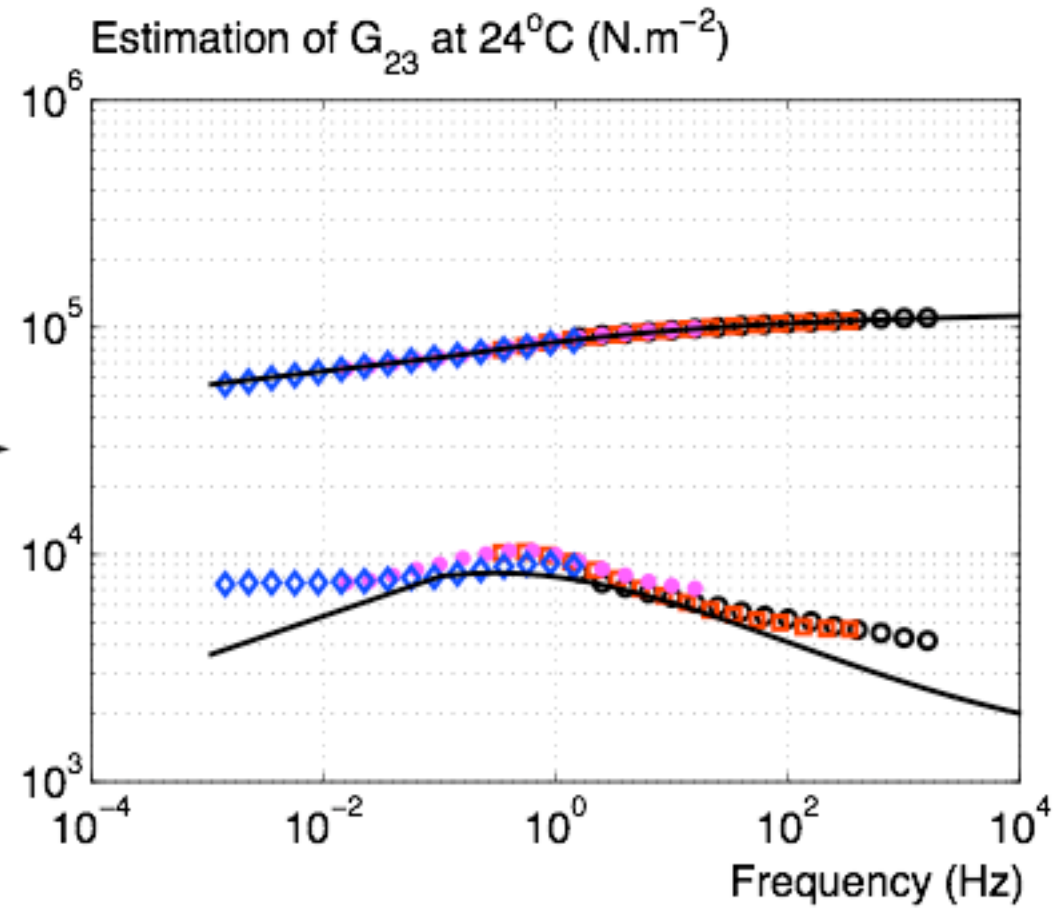

PROS

Low coupling between phases
(no change in volume, no shear in fluid).

CONS

No coupling taken into account in model.

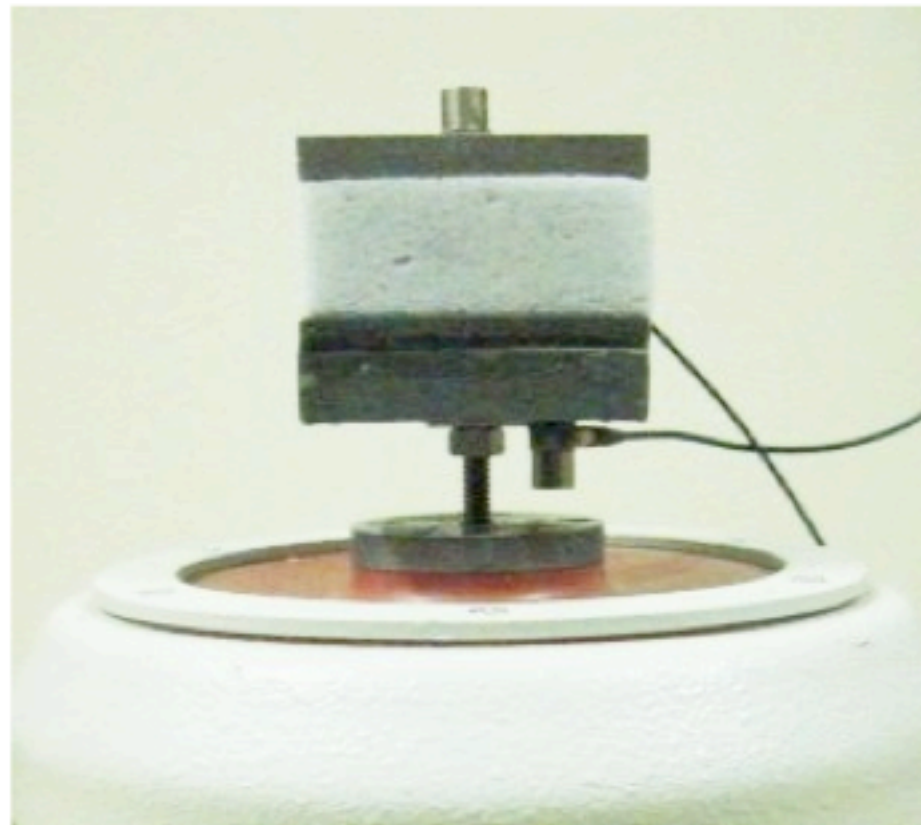

Set-up at ENTPE

T. Pritz 1980, 1982, 1994, DOI: [10.1006/jsvi.1994.1488](https://doi.org/10.1006/jsvi.1994.1488)

Melon et al. 1998, DOI: [10.1121/1.423897](https://doi.org/10.1121/1.423897)

Langlois et al. 2001, DOI: [10.1121/1.1419091](https://doi.org/10.1121/1.1419091)

Danilov et al. 2004, DOI: [10.1016/j.jsv.2003.08.036](https://doi.org/10.1016/j.jsv.2003.08.036)

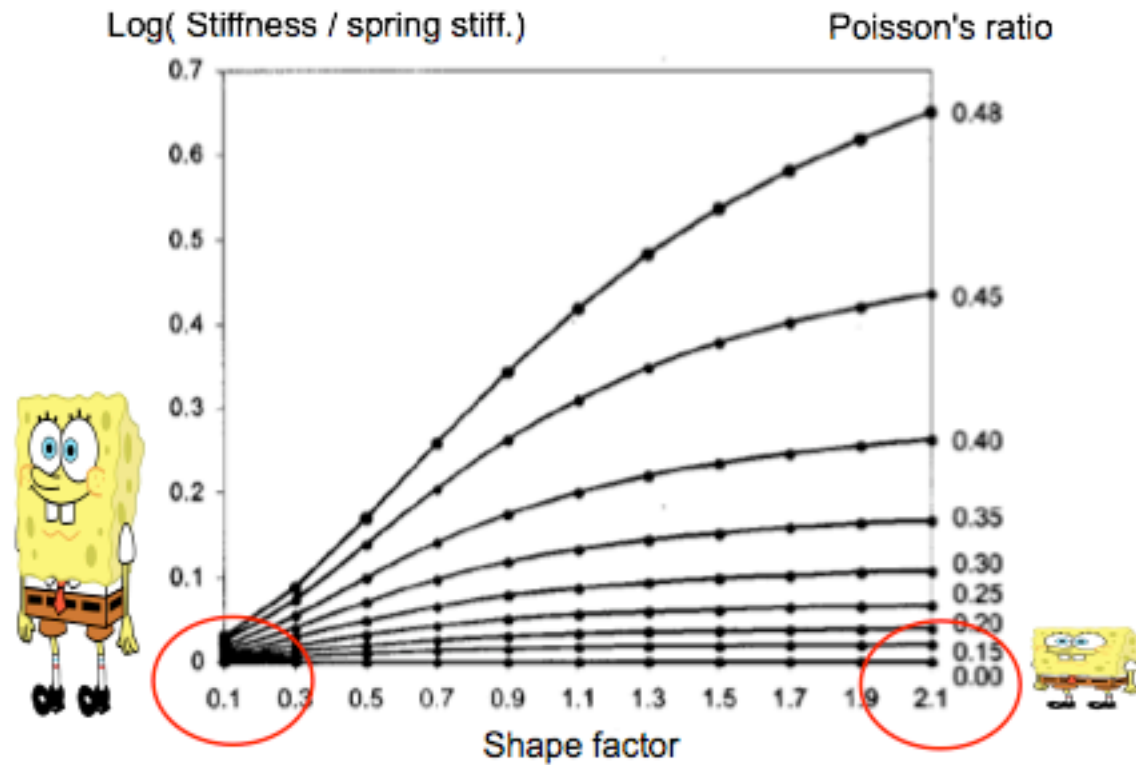

PROS

CONS

E and ν from one test (two samples).

Material is supposed isotropic.
Numerical inversions (abacus).

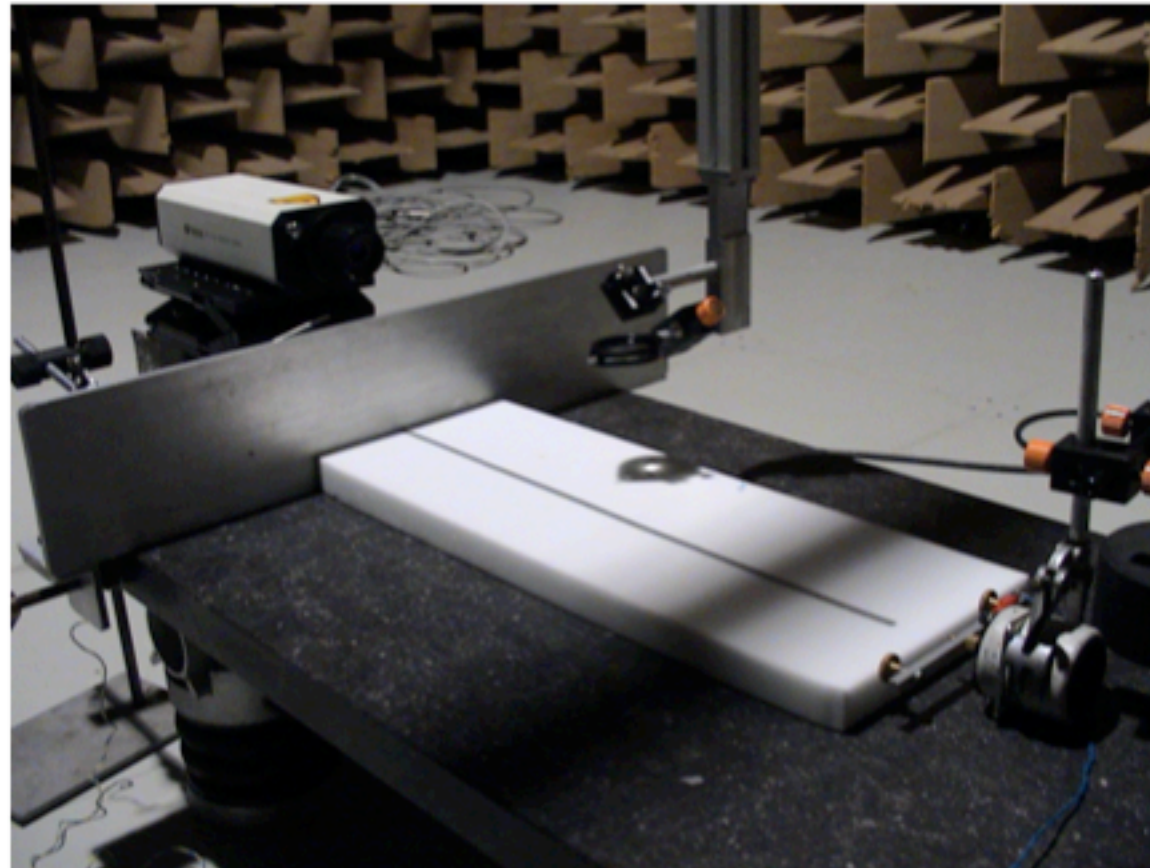

Picture courtesy of W. Lauriks

Boeckx et al. 2005, DOI: 10.1121/1.1847848

Boeckx et al. 2005, DOI: 10.1063/1.1886885

Geebelen et al. 2007, Link: www.ingentaconnect.com

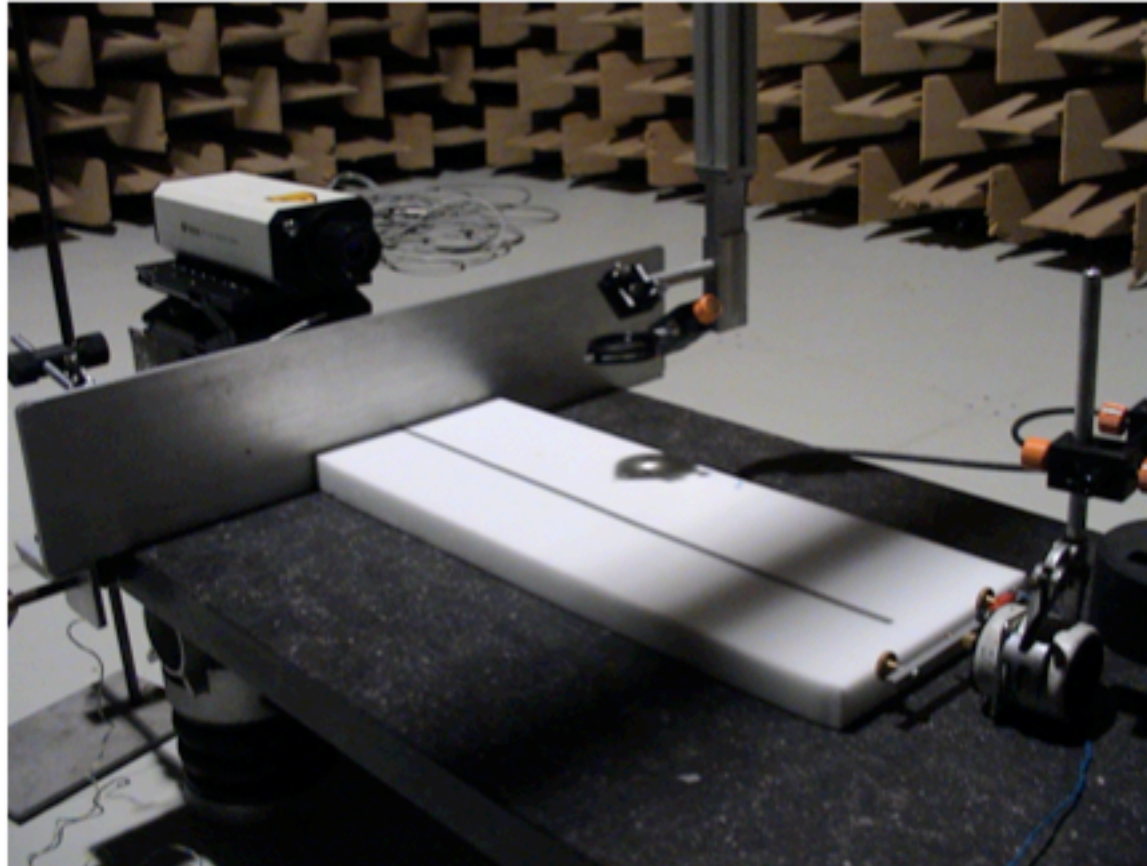

Picture courtesy of W. Lauriks

PROS

Measurements in acoustical freq. range.

CONS

Numerical inversions are used.

Measurement at one temperature only.

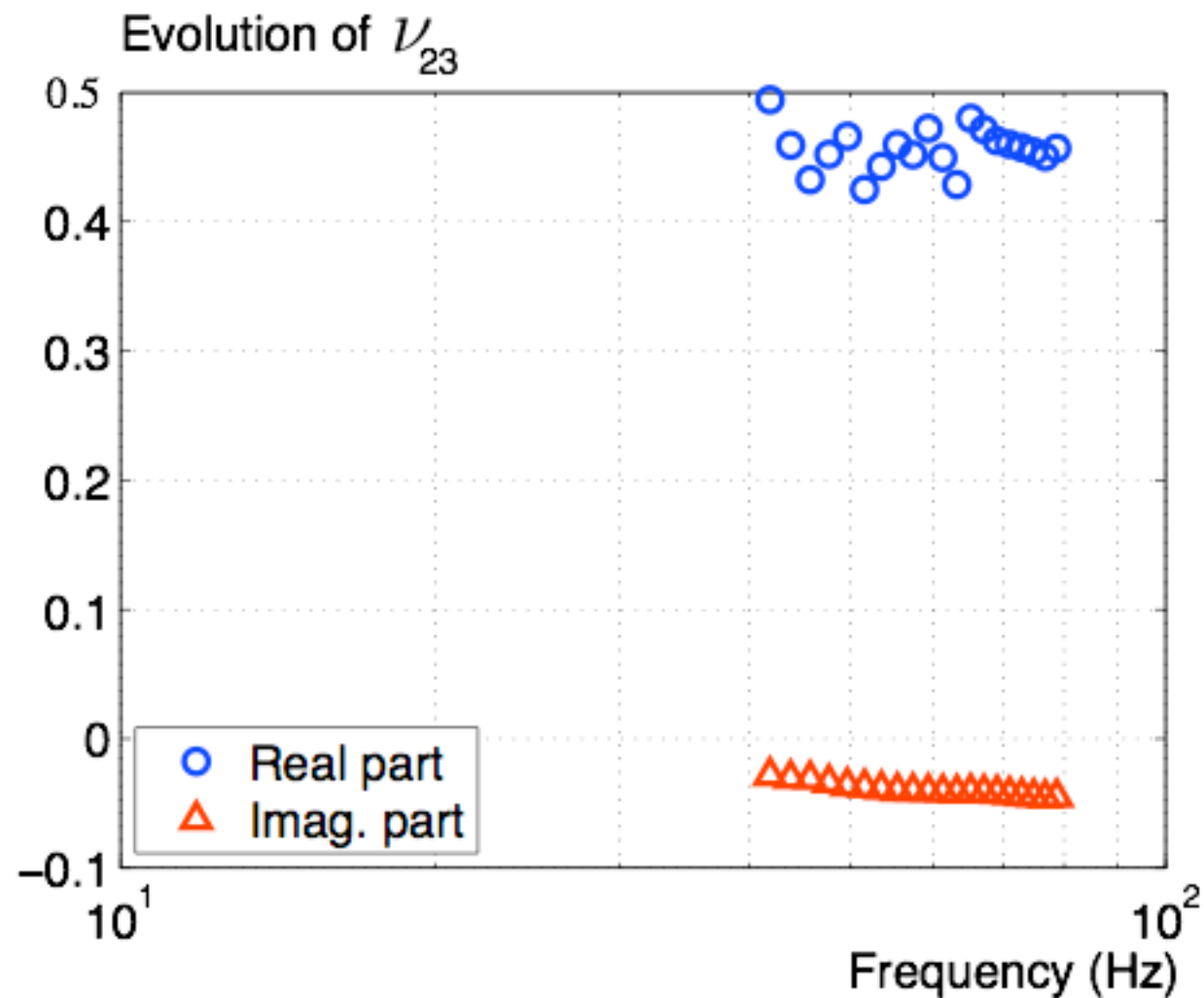

T. Pritz 1998 DOI: 10.1006/jsvi.1998.1534

Jaouen et al. 2008 DOI: 10.1016/j.apacoust.2007.11.008

For transversely isotropic materials (1st order approximation):

$$\nu_{LT} \simeq (1 - \phi)\nu_{solid}$$

and

$$\nu_{ji} = \nu_{ij} \frac{E_j}{E_i}$$

FIRST CONCLUSION

There is and will be
no perfect method
but
a bundle of complementary methods.

CONCLUSION & PERSPECTIVES

Acoustic characterization

- Many methods exist,
- still α_0' (and α_0) are not characterized.
(perspectives at low freq. with long impedance tube).

Visco-elastic characterization

- Broadband characterization is still the exception.
- Too few work on anisotropy.

THE LAST WORDS

"Some works suggest that the curiosity of the methods is more important than the results... In my opinion, the simpler the method the better to have reliable results".

Tamas Pritz

Thank you
for
your attention

